

1

| | | |
|--|--|--|
| $ \begin{array}{r} + \\ \begin{array}{ c c } \hline 4 & 5 \\ \hline 4 & 4 \\ \hline \end{array} \end{array} $ <div style="display: flex; justify-content: center; gap: 10px;"> <div style="border: 1px solid black; border-radius: 50%; width: 20px; height: 20px; display: flex; align-items: center; justify-content: center;">9</div> <div style="border: 1px solid black; border-radius: 50%; width: 20px; height: 20px;"></div> </div> <div style="display: flex; justify-content: center; gap: 10px; margin-top: 10px;"> <div style="border: 1px solid black; border-radius: 50%; width: 20px; height: 20px;"></div> <div style="border: 1px solid black; border-radius: 50%; width: 20px; height: 20px;"></div> </div> | $ \begin{array}{r} + \\ \begin{array}{ c c } \hline 2 & 7 \\ \hline 6 & 2 \\ \hline \end{array} \end{array} $ <div style="display: flex; justify-content: center; gap: 10px;"> <div style="border: 1px solid black; border-radius: 50%; width: 20px; height: 20px;"></div> <div style="border: 1px solid black; border-radius: 50%; width: 20px; height: 20px;"></div> </div> <div style="display: flex; justify-content: center; gap: 10px; margin-top: 10px;"> <div style="border: 1px solid black; border-radius: 50%; width: 20px; height: 20px;"></div> <div style="border: 1px solid black; border-radius: 50%; width: 20px; height: 20px;"></div> </div> | $ \begin{array}{r} + \\ \begin{array}{ c c } \hline 4 & 2 \\ \hline 3 & 3 \\ \hline \end{array} \end{array} $ <div style="display: flex; justify-content: center; gap: 10px;"> <div style="border: 1px solid black; border-radius: 50%; width: 20px; height: 20px;"></div> <div style="border: 1px solid black; border-radius: 50%; width: 20px; height: 20px;"></div> </div> <div style="display: flex; justify-content: center; gap: 10px; margin-top: 10px;"> <div style="border: 1px solid black; border-radius: 50%; width: 20px; height: 20px;"></div> <div style="border: 1px solid black; border-radius: 50%; width: 20px; height: 20px;"></div> </div> |
|--|--|--|

| | | |
|--|--|--|
| $ \begin{array}{r} + \\ \begin{array}{ c c } \hline 1 & \\ \hline & 3 \\ \hline \end{array} \end{array} $ <div style="display: flex; justify-content: center; gap: 10px;"> <div style="border: 1px solid black; border-radius: 50%; width: 20px; height: 20px;"></div> <div style="border: 1px solid black; border-radius: 50%; width: 20px; height: 20px;"></div> </div> <div style="display: flex; justify-content: center; gap: 10px; margin-top: 10px;"> <div style="border: 1px solid black; border-radius: 50%; width: 20px; height: 20px; display: flex; align-items: center; justify-content: center;">5</div> <div style="border: 1px solid black; border-radius: 50%; width: 20px; height: 20px; display: flex; align-items: center; justify-content: center;">6</div> </div> | $ \begin{array}{r} + \\ \begin{array}{ c c } \hline 1 & \\ \hline & 2 \\ \hline \end{array} \end{array} $ <div style="display: flex; justify-content: center; gap: 10px;"> <div style="border: 1px solid black; border-radius: 50%; width: 20px; height: 20px;"></div> <div style="border: 1px solid black; border-radius: 50%; width: 20px; height: 20px;"></div> </div> <div style="display: flex; justify-content: center; gap: 10px; margin-top: 10px;"> <div style="border: 1px solid black; border-radius: 50%; width: 20px; height: 20px; display: flex; align-items: center; justify-content: center;">8</div> <div style="border: 1px solid black; border-radius: 50%; width: 20px; height: 20px; display: flex; align-items: center; justify-content: center;">6</div> </div> | $ \begin{array}{r} + \\ \begin{array}{ c c } \hline 5 & \\ \hline & 3 \\ \hline \end{array} \end{array} $ <div style="display: flex; justify-content: center; gap: 10px;"> <div style="border: 1px solid black; border-radius: 50%; width: 20px; height: 20px;"></div> <div style="border: 1px solid black; border-radius: 50%; width: 20px; height: 20px;"></div> </div> <div style="display: flex; justify-content: center; gap: 10px; margin-top: 10px;"> <div style="border: 1px solid black; border-radius: 50%; width: 20px; height: 20px; display: flex; align-items: center; justify-content: center;">7</div> <div style="border: 1px solid black; border-radius: 50%; width: 20px; height: 20px; display: flex; align-items: center; justify-content: center;">7</div> </div> |
|--|--|--|

| | | |
|--|--|--|
| $ \begin{array}{r} + \\ \begin{array}{ c c } \hline 2 & \\ \hline & 5 \\ \hline \end{array} \end{array} $ <div style="display: flex; justify-content: center; gap: 10px;"> <div style="border: 1px solid black; border-radius: 50%; width: 20px; height: 20px;"></div> <div style="border: 1px solid black; border-radius: 50%; width: 20px; height: 20px;"></div> </div> <div style="display: flex; justify-content: center; gap: 10px; margin-top: 10px;"> <div style="border: 1px solid black; border-radius: 50%; width: 20px; height: 20px; display: flex; align-items: center; justify-content: center;">9</div> <div style="border: 1px solid black; border-radius: 50%; width: 20px; height: 20px; display: flex; align-items: center; justify-content: center;">6</div> </div> | $ \begin{array}{r} + \\ \begin{array}{ c c } \hline 3 & \\ \hline & 4 \\ \hline \end{array} \end{array} $ <div style="display: flex; justify-content: center; gap: 10px;"> <div style="border: 1px solid black; border-radius: 50%; width: 20px; height: 20px;"></div> <div style="border: 1px solid black; border-radius: 50%; width: 20px; height: 20px;"></div> </div> <div style="display: flex; justify-content: center; gap: 10px; margin-top: 10px;"> <div style="border: 1px solid black; border-radius: 50%; width: 20px; height: 20px; display: flex; align-items: center; justify-content: center;">8</div> <div style="border: 1px solid black; border-radius: 50%; width: 20px; height: 20px; display: flex; align-items: center; justify-content: center;">5</div> </div> | $ \begin{array}{r} + \\ \begin{array}{ c c } \hline 4 & \\ \hline & 5 \\ \hline \end{array} \end{array} $ <div style="display: flex; justify-content: center; gap: 10px;"> <div style="border: 1px solid black; border-radius: 50%; width: 20px; height: 20px;"></div> <div style="border: 1px solid black; border-radius: 50%; width: 20px; height: 20px;"></div> </div> <div style="display: flex; justify-content: center; gap: 10px; margin-top: 10px;"> <div style="border: 1px solid black; border-radius: 50%; width: 20px; height: 20px; display: flex; align-items: center; justify-content: center;">7</div> <div style="border: 1px solid black; border-radius: 50%; width: 20px; height: 20px; display: flex; align-items: center; justify-content: center;">7</div> </div> |
|--|--|--|

| | | | | | | | | | | | | | | | | | | | | | | | | | | | | | | | | | | | | | | | | | | | | | | | | | | |
|--|---|---|---|---|---|--|--|--|---|--|--|--|---|--|--|--|--|---|---|---|---|---|--|--|--|---|--|--|--|---|--|--|--|--|---|---|---|---|---|--|--|--|---|--|--|--|---|--|--|--|
| <table style="border-collapse: collapse; margin: auto;"> <tr><td style="padding: 5px;">+</td><td style="padding: 5px;">2</td><td style="padding: 5px;">5</td><td style="padding: 5px;">4</td></tr> <tr><td style="padding: 5px;">2</td><td style="padding: 5px;"></td><td style="padding: 5px;"></td><td style="padding: 5px;"></td></tr> <tr><td style="padding: 5px;">4</td><td style="padding: 5px;"></td><td style="padding: 5px;"></td><td style="padding: 5px;"></td></tr> <tr><td style="padding: 5px;">3</td><td style="padding: 5px;"></td><td style="padding: 5px;"></td><td style="padding: 5px;"></td></tr> </table> | + | 2 | 5 | 4 | 2 | | | | 4 | | | | 3 | | | | <table style="border-collapse: collapse; margin: auto;"> <tr><td style="padding: 5px;">+</td><td style="padding: 5px;">2</td><td style="padding: 5px;">4</td><td style="padding: 5px;">3</td></tr> <tr><td style="padding: 5px;">3</td><td style="padding: 5px;"></td><td style="padding: 5px;"></td><td style="padding: 5px;"></td></tr> <tr><td style="padding: 5px;">4</td><td style="padding: 5px;"></td><td style="padding: 5px;"></td><td style="padding: 5px;"></td></tr> <tr><td style="padding: 5px;">5</td><td style="padding: 5px;"></td><td style="padding: 5px;"></td><td style="padding: 5px;"></td></tr> </table> | + | 2 | 4 | 3 | 3 | | | | 4 | | | | 5 | | | | <table style="border-collapse: collapse; margin: auto;"> <tr><td style="padding: 5px;">+</td><td style="padding: 5px;">2</td><td style="padding: 5px;">3</td><td style="padding: 5px;">6</td></tr> <tr><td style="padding: 5px;">1</td><td style="padding: 5px;"></td><td style="padding: 5px;"></td><td style="padding: 5px;"></td></tr> <tr><td style="padding: 5px;">3</td><td style="padding: 5px;"></td><td style="padding: 5px;"></td><td style="padding: 5px;"></td></tr> <tr><td style="padding: 5px;">2</td><td style="padding: 5px;"></td><td style="padding: 5px;"></td><td style="padding: 5px;"></td></tr> </table> | + | 2 | 3 | 6 | 1 | | | | 3 | | | | 2 | | | |
| + | 2 | 5 | 4 | | | | | | | | | | | | | | | | | | | | | | | | | | | | | | | | | | | | | | | | | | | | | | | |
| 2 | | | | | | | | | | | | | | | | | | | | | | | | | | | | | | | | | | | | | | | | | | | | | | | | | | |
| 4 | | | | | | | | | | | | | | | | | | | | | | | | | | | | | | | | | | | | | | | | | | | | | | | | | | |
| 3 | | | | | | | | | | | | | | | | | | | | | | | | | | | | | | | | | | | | | | | | | | | | | | | | | | |
| + | 2 | 4 | 3 | | | | | | | | | | | | | | | | | | | | | | | | | | | | | | | | | | | | | | | | | | | | | | | |
| 3 | | | | | | | | | | | | | | | | | | | | | | | | | | | | | | | | | | | | | | | | | | | | | | | | | | |
| 4 | | | | | | | | | | | | | | | | | | | | | | | | | | | | | | | | | | | | | | | | | | | | | | | | | | |
| 5 | | | | | | | | | | | | | | | | | | | | | | | | | | | | | | | | | | | | | | | | | | | | | | | | | | |
| + | 2 | 3 | 6 | | | | | | | | | | | | | | | | | | | | | | | | | | | | | | | | | | | | | | | | | | | | | | | |
| 1 | | | | | | | | | | | | | | | | | | | | | | | | | | | | | | | | | | | | | | | | | | | | | | | | | | |
| 3 | | | | | | | | | | | | | | | | | | | | | | | | | | | | | | | | | | | | | | | | | | | | | | | | | | |
| 2 | | | | | | | | | | | | | | | | | | | | | | | | | | | | | | | | | | | | | | | | | | | | | | | | | | |

| | | | | | | | | | | | | | | | | | | | | | | | | | | | | | | | | | | | | | | | | | | | | | | | | | | |
|--|---|---|---|---|---|--|--|--|---|--|--|--|---|--|--|--|--|---|---|---|---|---|--|--|--|---|--|--|--|---|--|--|--|--|---|---|---|---|---|--|--|--|---|--|--|--|---|--|--|--|
| <table style="border-collapse: collapse; margin: auto;"> <tr><td style="padding: 5px;">+</td><td style="padding: 5px;">5</td><td style="padding: 5px;">2</td><td style="padding: 5px;">4</td></tr> <tr><td style="padding: 5px;">5</td><td style="padding: 5px;"></td><td style="padding: 5px;"></td><td style="padding: 5px;"></td></tr> <tr><td style="padding: 5px;">6</td><td style="padding: 5px;"></td><td style="padding: 5px;"></td><td style="padding: 5px;"></td></tr> <tr><td style="padding: 5px;">7</td><td style="padding: 5px;"></td><td style="padding: 5px;"></td><td style="padding: 5px;"></td></tr> </table> | + | 5 | 2 | 4 | 5 | | | | 6 | | | | 7 | | | | <table style="border-collapse: collapse; margin: auto;"> <tr><td style="padding: 5px;">+</td><td style="padding: 5px;">4</td><td style="padding: 5px;">3</td><td style="padding: 5px;">5</td></tr> <tr><td style="padding: 5px;">6</td><td style="padding: 5px;"></td><td style="padding: 5px;"></td><td style="padding: 5px;"></td></tr> <tr><td style="padding: 5px;">2</td><td style="padding: 5px;"></td><td style="padding: 5px;"></td><td style="padding: 5px;"></td></tr> <tr><td style="padding: 5px;">5</td><td style="padding: 5px;"></td><td style="padding: 5px;"></td><td style="padding: 5px;"></td></tr> </table> | + | 4 | 3 | 5 | 6 | | | | 2 | | | | 5 | | | | <table style="border-collapse: collapse; margin: auto;"> <tr><td style="padding: 5px;">+</td><td style="padding: 5px;">6</td><td style="padding: 5px;">3</td><td style="padding: 5px;">5</td></tr> <tr><td style="padding: 5px;">7</td><td style="padding: 5px;"></td><td style="padding: 5px;"></td><td style="padding: 5px;"></td></tr> <tr><td style="padding: 5px;">8</td><td style="padding: 5px;"></td><td style="padding: 5px;"></td><td style="padding: 5px;"></td></tr> <tr><td style="padding: 5px;">6</td><td style="padding: 5px;"></td><td style="padding: 5px;"></td><td style="padding: 5px;"></td></tr> </table> | + | 6 | 3 | 5 | 7 | | | | 8 | | | | 6 | | | |
| + | 5 | 2 | 4 | | | | | | | | | | | | | | | | | | | | | | | | | | | | | | | | | | | | | | | | | | | | | | | |
| 5 | | | | | | | | | | | | | | | | | | | | | | | | | | | | | | | | | | | | | | | | | | | | | | | | | | |
| 6 | | | | | | | | | | | | | | | | | | | | | | | | | | | | | | | | | | | | | | | | | | | | | | | | | | |
| 7 | | | | | | | | | | | | | | | | | | | | | | | | | | | | | | | | | | | | | | | | | | | | | | | | | | |
| + | 4 | 3 | 5 | | | | | | | | | | | | | | | | | | | | | | | | | | | | | | | | | | | | | | | | | | | | | | | |
| 6 | | | | | | | | | | | | | | | | | | | | | | | | | | | | | | | | | | | | | | | | | | | | | | | | | | |
| 2 | | | | | | | | | | | | | | | | | | | | | | | | | | | | | | | | | | | | | | | | | | | | | | | | | | |
| 5 | | | | | | | | | | | | | | | | | | | | | | | | | | | | | | | | | | | | | | | | | | | | | | | | | | |
| + | 6 | 3 | 5 | | | | | | | | | | | | | | | | | | | | | | | | | | | | | | | | | | | | | | | | | | | | | | | |
| 7 | | | | | | | | | | | | | | | | | | | | | | | | | | | | | | | | | | | | | | | | | | | | | | | | | | |
| 8 | | | | | | | | | | | | | | | | | | | | | | | | | | | | | | | | | | | | | | | | | | | | | | | | | | |
| 6 | | | | | | | | | | | | | | | | | | | | | | | | | | | | | | | | | | | | | | | | | | | | | | | | | | |

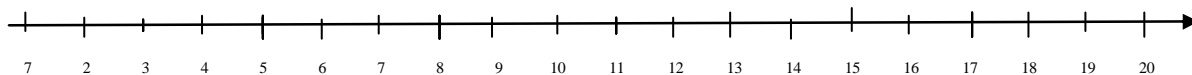

| | | |
|-----------------------------|-----------------------------|-----------------------------|
| $8 + 2 = \underline{\quad}$ | $3 + 8 = \underline{\quad}$ | $5 + 7 = \underline{\quad}$ |
|-----------------------------|-----------------------------|-----------------------------|

| | | |
|-----------------------------|-----------------------------|-----------------------------|
| $3 + 9 = \underline{\quad}$ | $4 + 8 = \underline{\quad}$ | $5 + 8 = \underline{\quad}$ |
|-----------------------------|-----------------------------|-----------------------------|

| | | |
|-----------------------------|-----------------------------|-----------------------------|
| $8 + 4 = \underline{\quad}$ | $6 + 8 = \underline{\quad}$ | $6 + 6 = \underline{\quad}$ |
|-----------------------------|-----------------------------|-----------------------------|

| | | |
|-----------------------------|-----------------------------|-----------------------------|
| $8 + 7 = \underline{\quad}$ | $4 + 9 = \underline{\quad}$ | $6 + 9 = \underline{\quad}$ |
|-----------------------------|-----------------------------|-----------------------------|

| | | |
|-----------------------------|-----------------------------|-----------------------------|
| $6 + 7 = \underline{\quad}$ | $6 + 8 = \underline{\quad}$ | $8 + 7 = \underline{\quad}$ |
|-----------------------------|-----------------------------|-----------------------------|

| | | |
|-----------------------------|-----------------------------|-----------------------------|
| $8 + 6 = \underline{\quad}$ | $3 + 8 = \underline{\quad}$ | $4 + 7 = \underline{\quad}$ |
|-----------------------------|-----------------------------|-----------------------------|

| | | |
|-----------------------------|-----------------------------|-----------------------------|
| $8 + 5 = \underline{\quad}$ | $8 + 9 = \underline{\quad}$ | $7 + 7 = \underline{\quad}$ |
|-----------------------------|-----------------------------|-----------------------------|

| | | |
|-----------------------------|-----------------------------|-----------------------------|
| $8 + 4 = \underline{\quad}$ | $5 + 9 = \underline{\quad}$ | $5 + 6 = \underline{\quad}$ |
|-----------------------------|-----------------------------|-----------------------------|

| | | |
|-----------------------------|-----------------------------|-----------------------------|
| $8 + 8 = \underline{\quad}$ | $9 + 9 = \underline{\quad}$ | $9 + 5 = \underline{\quad}$ |
|-----------------------------|-----------------------------|-----------------------------|

| | | |
|-----------------------------|-----------------------------|-----------------------------|
| $6 + 5 = \underline{\quad}$ | $3 + 8 = \underline{\quad}$ | $5 + 7 = \underline{\quad}$ |
|-----------------------------|-----------------------------|-----------------------------|

| | | |
|-----------------------------|-----------------------------|-----------------------------|
| $8 + 2 = \underline{\quad}$ | $4 + 8 = \underline{\quad}$ | $7 + 7 = \underline{\quad}$ |
|-----------------------------|-----------------------------|-----------------------------|

| | | |
|-----------------------------------|-----------------------------------|-------------------------------------|
| 2 $\xrightarrow{\boxed{4}}$ 6 | 3 $\xrightarrow{\boxed{\quad}}$ 9 | 11 $\xrightarrow{\boxed{\quad}}$ 13 |
| 3 $\xrightarrow{\boxed{\quad}}$ 7 | 4 $\xrightarrow{\boxed{\quad}}$ 8 | 14 $\xrightarrow{\boxed{\quad}}$ 17 |
| 2 $\xrightarrow{\boxed{\quad}}$ 8 | 5 $\xrightarrow{\boxed{\quad}}$ 9 | 12 $\xrightarrow{\boxed{\quad}}$ 16 |
| 7 $\xrightarrow{\boxed{3}}$ | 4 $\xrightarrow{\boxed{5}}$ | 11 $\xrightarrow{\boxed{7}}$ |
| 8 $\xrightarrow{\boxed{2}}$ | 1 $\xrightarrow{\boxed{8}}$ | 11 $\xrightarrow{\boxed{6}}$ |
| 1 $\xrightarrow{\boxed{7}}$ | 2 $\xrightarrow{\boxed{5}}$ | 13 $\xrightarrow{\boxed{5}}$ |

| | | |
|-----------------------------|-----------------------------|-----------------------------|
| $8 - 2 = \underline{\quad}$ | $8 - 3 = \underline{\quad}$ | $7 - 5 = \underline{\quad}$ |
|-----------------------------|-----------------------------|-----------------------------|

| | | |
|-----------------------------|-----------------------------|-----------------------------|
| $9 - 3 = \underline{\quad}$ | $8 - 4 = \underline{\quad}$ | $8 - 5 = \underline{\quad}$ |
|-----------------------------|-----------------------------|-----------------------------|

| | | |
|-----------------------------|-----------------------------|-----------------------------|
| $8 - 1 = \underline{\quad}$ | $8 - 6 = \underline{\quad}$ | $7 - 6 = \underline{\quad}$ |
|-----------------------------|-----------------------------|-----------------------------|

| | | |
|-----------------------------|-----------------------------|-----------------------------|
| $8 - 7 = \underline{\quad}$ | $9 - 4 = \underline{\quad}$ | $9 - 6 = \underline{\quad}$ |
|-----------------------------|-----------------------------|-----------------------------|

| | | |
|-----------------------------|-----------------------------|-----------------------------|
| $9 - 8 = \underline{\quad}$ | $9 - 1 = \underline{\quad}$ | $9 - 5 = \underline{\quad}$ |
|-----------------------------|-----------------------------|-----------------------------|

| | | |
|-----------------------------|-----------------------------|-----------------------------|
| $6 - 5 = \underline{\quad}$ | $9 - 3 = \underline{\quad}$ | $9 - 7 = \underline{\quad}$ |
|-----------------------------|-----------------------------|-----------------------------|

| | | |
|-----------------------------|-----------------------------|-----------------------------|
| $9 - 2 = \underline{\quad}$ | $6 - 3 = \underline{\quad}$ | $7 - 1 = \underline{\quad}$ |
|-----------------------------|-----------------------------|-----------------------------|

> < eller =

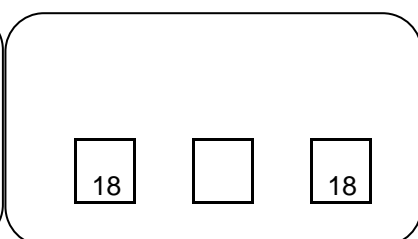
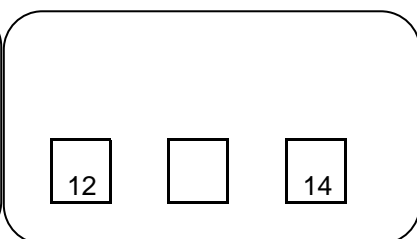
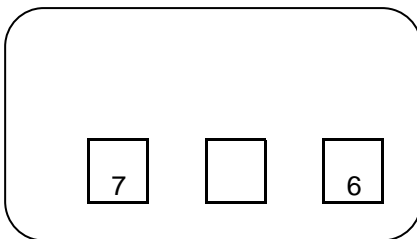
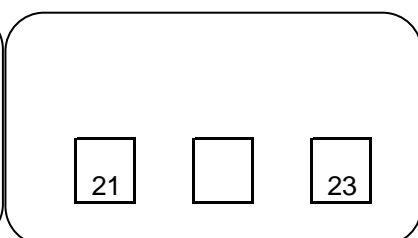
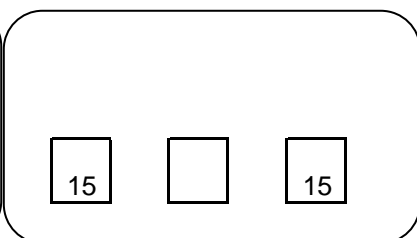
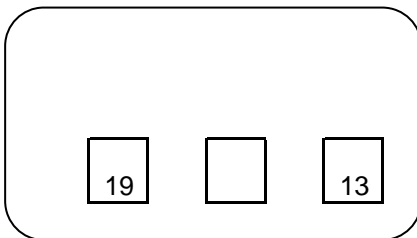
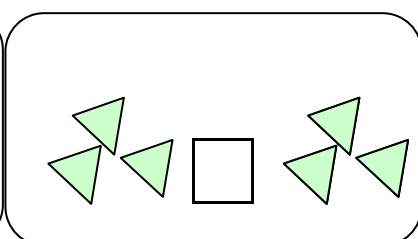
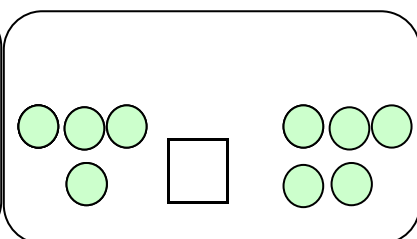
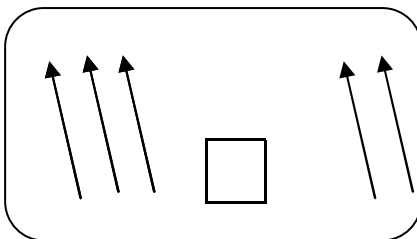
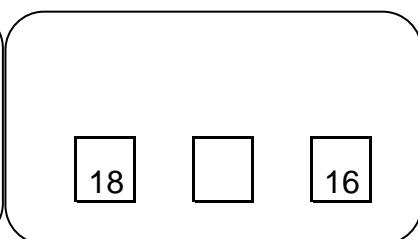
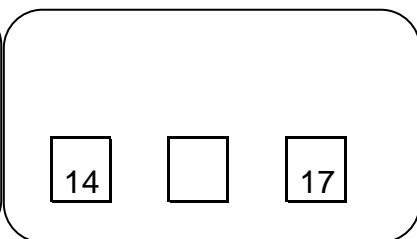
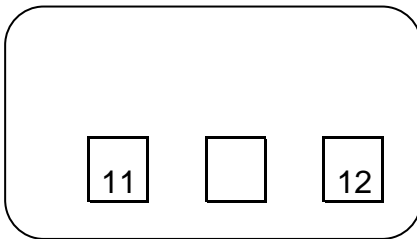
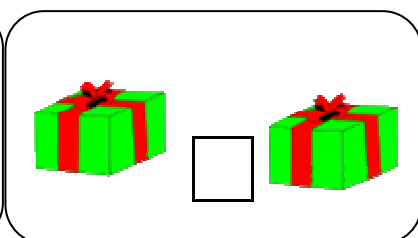
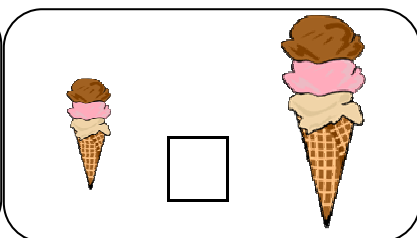
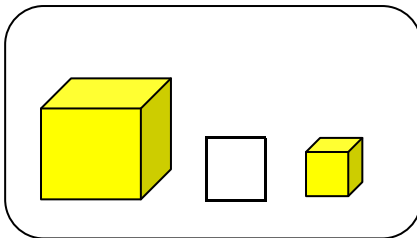
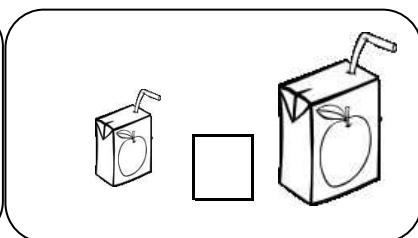
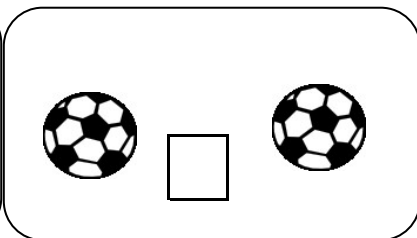
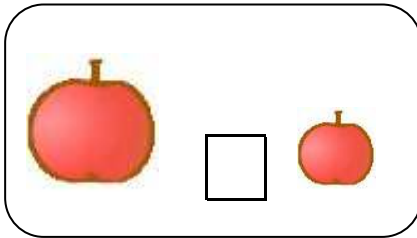
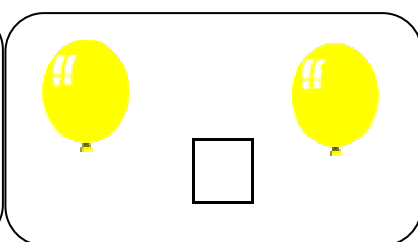
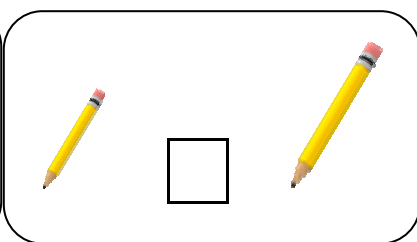
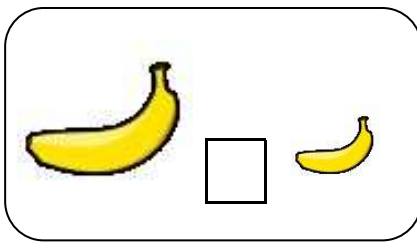

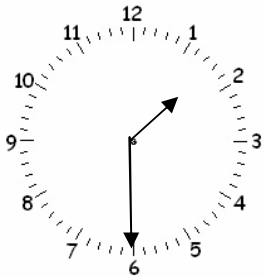
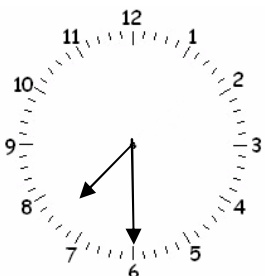
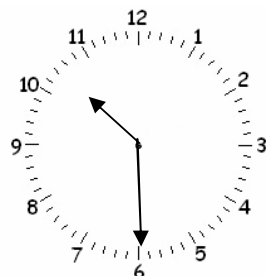
| | | |
|---|---|---|
|  |  |  |
| Klokken er: _____ | Klokken er: _____ | Klokken er: _____ |

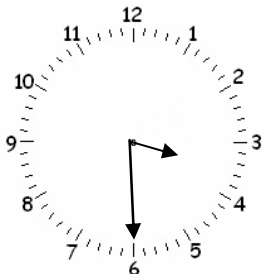
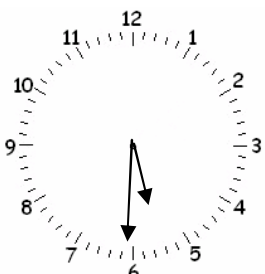
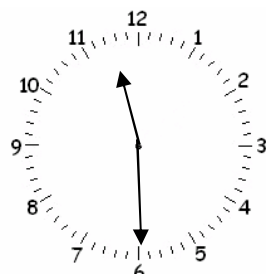
| | | |
|---|---|---|
|  |  |  |
| Klokken er: _____ | Klokken er: _____ | Klokken er: _____ |

Tegn:

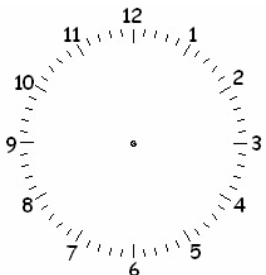
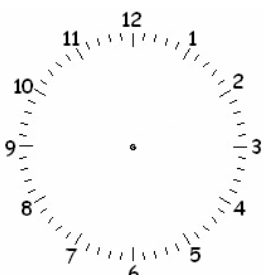
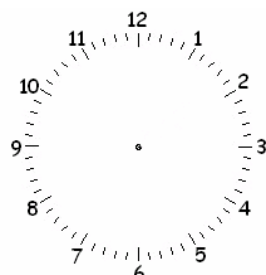
| | | |
|---|---|---|
|  |  |  |
| Klokken er: <u>8.30</u> | Klokken er: <u>3.30</u> | Klokken er: <u>2</u> |

Tegn:

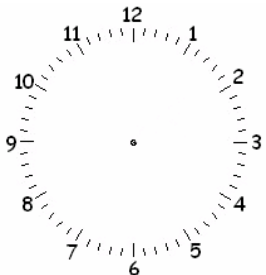
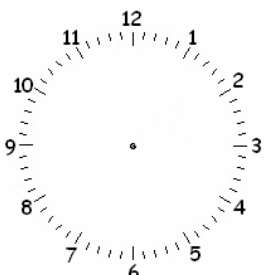
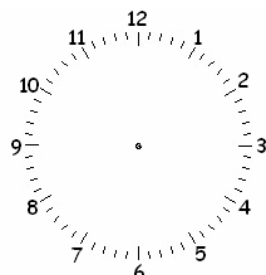
| | | |
|---|---|---|
|  |  |  |
| Klokken er: <u>5</u> | Klokken er: <u>11</u> | Klokken er: <u>12</u> |

| | | | | | | | | | | | | | | | | | | | | | | | | | | | | | |
|---|---|---|---|---|--|--|---|--|--|---|---|--|--|--|--|--|--|--|--|---|---|--|--|--|--|--|--|--|--|
| <p style="text-align: center;">$+ 2 \rightarrow$</p> <table border="1" style="margin-left: auto; margin-right: auto;"> <tr><td>1</td><td>3</td><td>5</td></tr> <tr><td>4</td><td></td><td></td></tr> <tr><td>7</td><td></td><td></td></tr> </table> <p style="text-align: left;">$\downarrow + 3$</p> | 1 | 3 | 5 | 4 | | | 7 | | | <p style="text-align: center;">$+ 1 \rightarrow$</p> <table border="1" style="margin-left: auto; margin-right: auto;"> <tr><td>1</td><td></td><td></td></tr> <tr><td></td><td></td><td></td></tr> <tr><td></td><td></td><td></td></tr> </table> <p style="text-align: left;">$\downarrow + 2$</p> | 1 | | | | | | | | | <p style="text-align: center;">$+ 2 \rightarrow$</p> <table border="1" style="margin-left: auto; margin-right: auto;"> <tr><td>0</td><td></td><td></td></tr> <tr><td></td><td></td><td></td></tr> <tr><td></td><td></td><td></td></tr> </table> <p style="text-align: left;">$\downarrow + 3$</p> | 0 | | | | | | | | |
| 1 | 3 | 5 | | | | | | | | | | | | | | | | | | | | | | | | | | | |
| 4 | | | | | | | | | | | | | | | | | | | | | | | | | | | | | |
| 7 | | | | | | | | | | | | | | | | | | | | | | | | | | | | | |
| 1 | | | | | | | | | | | | | | | | | | | | | | | | | | | | | |
| | | | | | | | | | | | | | | | | | | | | | | | | | | | | | |
| | | | | | | | | | | | | | | | | | | | | | | | | | | | | | |
| 0 | | | | | | | | | | | | | | | | | | | | | | | | | | | | | |
| | | | | | | | | | | | | | | | | | | | | | | | | | | | | | |
| | | | | | | | | | | | | | | | | | | | | | | | | | | | | | |
| <p style="text-align: center;">$+ 5 \rightarrow$</p> <table border="1" style="margin-left: auto; margin-right: auto;"> <tr><td>2</td><td></td><td></td></tr> <tr><td></td><td></td><td></td></tr> <tr><td></td><td></td><td></td></tr> </table> <p style="text-align: left;">$\downarrow + 4$</p> | 2 | | | | | | | | | <p style="text-align: center;">$+ 2 \rightarrow$</p> <table border="1" style="margin-left: auto; margin-right: auto;"> <tr><td>3</td><td></td><td></td></tr> <tr><td></td><td></td><td></td></tr> <tr><td></td><td></td><td></td></tr> </table> <p style="text-align: left;">$\downarrow + 1$</p> | 3 | | | | | | | | | <p style="text-align: center;">$+ 1 \rightarrow$</p> <table border="1" style="margin-left: auto; margin-right: auto;"> <tr><td>0</td><td></td><td></td></tr> <tr><td></td><td></td><td></td></tr> <tr><td></td><td></td><td></td></tr> </table> <p style="text-align: left;">$\downarrow + 8$</p> | 0 | | | | | | | | |
| 2 | | | | | | | | | | | | | | | | | | | | | | | | | | | | | |
| | | | | | | | | | | | | | | | | | | | | | | | | | | | | | |
| | | | | | | | | | | | | | | | | | | | | | | | | | | | | | |
| 3 | | | | | | | | | | | | | | | | | | | | | | | | | | | | | |
| | | | | | | | | | | | | | | | | | | | | | | | | | | | | | |
| | | | | | | | | | | | | | | | | | | | | | | | | | | | | | |
| 0 | | | | | | | | | | | | | | | | | | | | | | | | | | | | | |
| | | | | | | | | | | | | | | | | | | | | | | | | | | | | | |
| | | | | | | | | | | | | | | | | | | | | | | | | | | | | | |
| <p style="text-align: center;">$+ 2 \rightarrow$</p> <table border="1" style="margin-left: auto; margin-right: auto;"> <tr><td>5</td><td></td><td></td></tr> <tr><td></td><td></td><td></td></tr> <tr><td></td><td></td><td></td></tr> </table> <p style="text-align: left;">$\downarrow + 3$</p> | 5 | | | | | | | | | <p style="text-align: center;">$+ 1 \rightarrow$</p> <table border="1" style="margin-left: auto; margin-right: auto;"> <tr><td>4</td><td></td><td></td></tr> <tr><td></td><td></td><td></td></tr> <tr><td></td><td></td><td></td></tr> </table> <p style="text-align: left;">$\downarrow + 2$</p> | 4 | | | | | | | | | <p style="text-align: center;">$+ 7 \rightarrow$</p> <table border="1" style="margin-left: auto; margin-right: auto;"> <tr><td>0</td><td></td><td></td></tr> <tr><td></td><td></td><td></td></tr> <tr><td></td><td></td><td></td></tr> </table> <p style="text-align: left;">$\downarrow + 5$</p> | 0 | | | | | | | | |
| 5 | | | | | | | | | | | | | | | | | | | | | | | | | | | | | |
| | | | | | | | | | | | | | | | | | | | | | | | | | | | | | |
| | | | | | | | | | | | | | | | | | | | | | | | | | | | | | |
| 4 | | | | | | | | | | | | | | | | | | | | | | | | | | | | | |
| | | | | | | | | | | | | | | | | | | | | | | | | | | | | | |
| | | | | | | | | | | | | | | | | | | | | | | | | | | | | | |
| 0 | | | | | | | | | | | | | | | | | | | | | | | | | | | | | |
| | | | | | | | | | | | | | | | | | | | | | | | | | | | | | |
| | | | | | | | | | | | | | | | | | | | | | | | | | | | | | |
| <p style="text-align: center;">$+ 6 \rightarrow$</p> <table border="1" style="margin-left: auto; margin-right: auto;"> <tr><td>1</td><td></td><td></td></tr> <tr><td></td><td></td><td></td></tr> <tr><td></td><td></td><td></td></tr> </table> <p style="text-align: left;">$\downarrow + 4$</p> | 1 | | | | | | | | | <p style="text-align: center;">$+ 1 \rightarrow$</p> <table border="1" style="margin-left: auto; margin-right: auto;"> <tr><td>1</td><td></td><td></td></tr> <tr><td></td><td></td><td></td></tr> <tr><td></td><td></td><td></td></tr> </table> <p style="text-align: left;">$\downarrow + 2$</p> | 1 | | | | | | | | | <p style="text-align: center;">$+ 2 \rightarrow$</p> <table border="1" style="margin-left: auto; margin-right: auto;"> <tr><td>0</td><td></td><td></td></tr> <tr><td></td><td></td><td></td></tr> <tr><td></td><td></td><td></td></tr> </table> <p style="text-align: left;">$\downarrow + 3$</p> | 0 | | | | | | | | |
| 1 | | | | | | | | | | | | | | | | | | | | | | | | | | | | | |
| | | | | | | | | | | | | | | | | | | | | | | | | | | | | | |
| | | | | | | | | | | | | | | | | | | | | | | | | | | | | | |
| 1 | | | | | | | | | | | | | | | | | | | | | | | | | | | | | |
| | | | | | | | | | | | | | | | | | | | | | | | | | | | | | |
| | | | | | | | | | | | | | | | | | | | | | | | | | | | | | |
| 0 | | | | | | | | | | | | | | | | | | | | | | | | | | | | | |
| | | | | | | | | | | | | | | | | | | | | | | | | | | | | | |
| | | | | | | | | | | | | | | | | | | | | | | | | | | | | | |
| <p style="text-align: center;">$+ 1 \rightarrow$</p> <table border="1" style="margin-left: auto; margin-right: auto;"> <tr><td>7</td><td></td><td></td></tr> <tr><td></td><td></td><td></td></tr> <tr><td></td><td></td><td></td></tr> </table> <p style="text-align: left;">$\downarrow + 3$</p> | 7 | | | | | | | | | <p style="text-align: center;">$+ 2 \rightarrow$</p> <table border="1" style="margin-left: auto; margin-right: auto;"> <tr><td>5</td><td></td><td></td></tr> <tr><td></td><td></td><td></td></tr> <tr><td></td><td></td><td></td></tr> </table> <p style="text-align: left;">$\downarrow + 4$</p> | 5 | | | | | | | | | <p style="text-align: center;">$+ 2 \rightarrow$</p> <table border="1" style="margin-left: auto; margin-right: auto;"> <tr><td>8</td><td></td><td></td></tr> <tr><td></td><td></td><td></td></tr> <tr><td></td><td></td><td></td></tr> </table> <p style="text-align: left;">$\downarrow + 3$</p> | 8 | | | | | | | | |
| 7 | | | | | | | | | | | | | | | | | | | | | | | | | | | | | |
| | | | | | | | | | | | | | | | | | | | | | | | | | | | | | |
| | | | | | | | | | | | | | | | | | | | | | | | | | | | | | |
| 5 | | | | | | | | | | | | | | | | | | | | | | | | | | | | | |
| | | | | | | | | | | | | | | | | | | | | | | | | | | | | | |
| | | | | | | | | | | | | | | | | | | | | | | | | | | | | | |
| 8 | | | | | | | | | | | | | | | | | | | | | | | | | | | | | |
| | | | | | | | | | | | | | | | | | | | | | | | | | | | | | |
| | | | | | | | | | | | | | | | | | | | | | | | | | | | | | |
| <p style="text-align: center;">$+ 1 \rightarrow$</p> <table border="1" style="margin-left: auto; margin-right: auto;"> <tr><td>0</td><td></td><td></td></tr> <tr><td></td><td></td><td></td></tr> <tr><td></td><td></td><td></td></tr> </table> <p style="text-align: left;">$\downarrow + 10$</p> | 0 | | | | | | | | | <p style="text-align: center;">$+ 2 \rightarrow$</p> <table border="1" style="margin-left: auto; margin-right: auto;"> <tr><td>7</td><td></td><td></td></tr> <tr><td></td><td></td><td></td></tr> <tr><td></td><td></td><td></td></tr> </table> <p style="text-align: left;">$\downarrow + 3$</p> | 7 | | | | | | | | | <p style="text-align: center;">$+ 4 \rightarrow$</p> <table border="1" style="margin-left: auto; margin-right: auto;"> <tr><td>8</td><td></td><td></td></tr> <tr><td></td><td></td><td></td></tr> <tr><td></td><td></td><td></td></tr> </table> <p style="text-align: left;">$\downarrow + 2$</p> | 8 | | | | | | | | |
| 0 | | | | | | | | | | | | | | | | | | | | | | | | | | | | | |
| | | | | | | | | | | | | | | | | | | | | | | | | | | | | | |
| | | | | | | | | | | | | | | | | | | | | | | | | | | | | | |
| 7 | | | | | | | | | | | | | | | | | | | | | | | | | | | | | |
| | | | | | | | | | | | | | | | | | | | | | | | | | | | | | |
| | | | | | | | | | | | | | | | | | | | | | | | | | | | | | |
| 8 | | | | | | | | | | | | | | | | | | | | | | | | | | | | | |
| | | | | | | | | | | | | | | | | | | | | | | | | | | | | | |
| | | | | | | | | | | | | | | | | | | | | | | | | | | | | | |

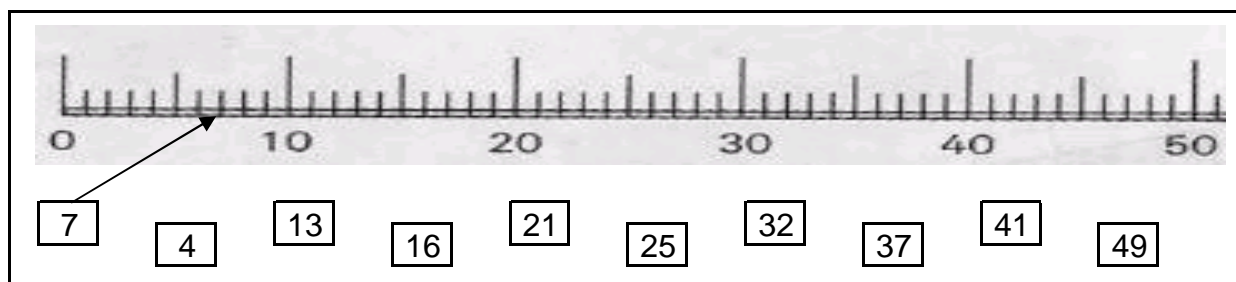

Vælg selv tal og forbind til tallinjen

Below the number line are ten empty boxes for writing numbers.

Nabotal

| | | | | | | | | |
|---|-----------|---|---|-----------|---|---|-----------|---|
| — | <u>14</u> | — | — | <u>11</u> | — | — | <u>24</u> | — |
| — | <u>19</u> | — | — | <u>22</u> | — | — | <u>8</u> | — |
| — | <u>12</u> | — | — | <u>3</u> | — | — | <u>16</u> | — |
| — | <u>7</u> | — | — | <u>13</u> | — | — | <u>9</u> | — |

Skriv tallene efter størrelse. Begynd med det mindste tal.

| | | |
|---|--|---|
| 12 7 14 7 10 3 5 17 <hr style="border: 1px solid black;"/> | 19 8 20 8 25 2 13 18 <hr style="border: 1px solid black;"/> | 11 2 16 2 23 14 1 15 <hr style="border: 1px solid black;"/> |
| 22 16 8 16 12 4 6 13 <hr style="border: 1px solid black;"/> | 23 25 11 25 9 16 15 5 <hr style="border: 1px solid black;"/> | 28 20 11 20 7 22 19 15 <hr style="border: 1px solid black;"/> |

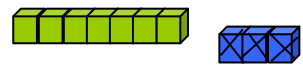

10 - 3 = 7

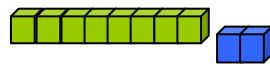

10 - =

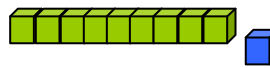

- =

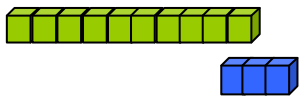

- =

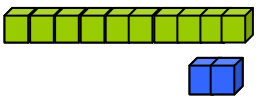

- =

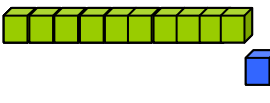

- =

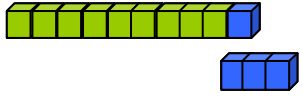

- 4 =

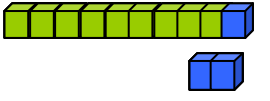

- =

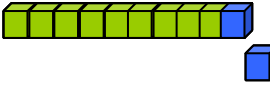

- =

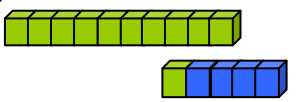

- 4 =

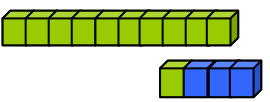

- =

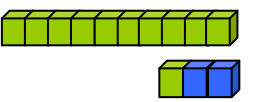

- =

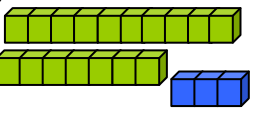

- =

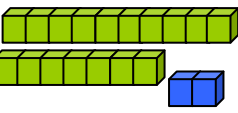

- =

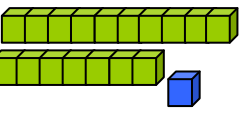

- =

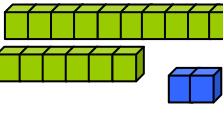

- =

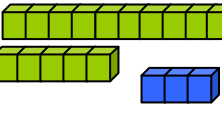

- =

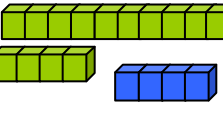

- =

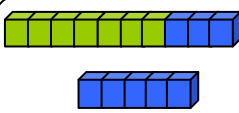

- =

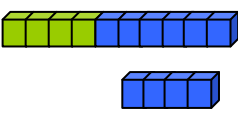

- =

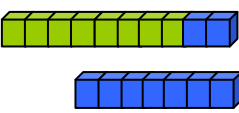

- =

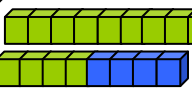

- =

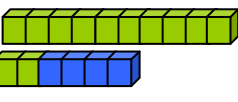

- =

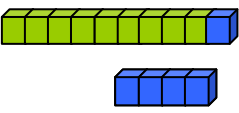

- =

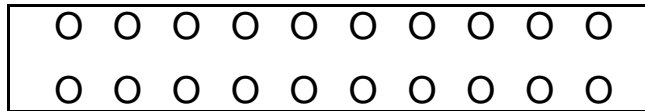

| | | |
|---|---|---|
| $5 + 4 = \underline{\quad}$ $7 + 4 = \underline{\quad}$ $9 + 4 = \underline{\quad}$ $4 + 4 = \underline{\quad}$ $8 + 4 = \underline{\quad}$ | $8 + 3 = \underline{\quad}$ $5 + 3 = \underline{\quad}$ $7 + 3 = \underline{\quad}$ $9 + 3 = \underline{\quad}$ $6 + 3 = \underline{\quad}$ | $5 + 6 = \underline{\quad}$ $4 + 6 = \underline{\quad}$ $9 + 6 = \underline{\quad}$ $8 + 6 = \underline{\quad}$ $7 + 6 = \underline{\quad}$ |
|---|---|---|

| | | |
|---|---|--|
| $5 - 4 = \underline{\quad}$ $7 - 4 = \underline{\quad}$ $9 - 4 = \underline{\quad}$ $4 - 4 = \underline{\quad}$ $8 - 4 = \underline{\quad}$ | $8 - 5 = \underline{\quad}$ $5 - 5 = \underline{\quad}$ $7 - 5 = \underline{\quad}$ $9 - 5 = \underline{\quad}$ $6 - 5 = \underline{\quad}$ | $15 - 6 = \underline{\quad}$ $14 - 8 = \underline{\quad}$ $15 - 7 = \underline{\quad}$ $11 - 6 = \underline{\quad}$ $12 - 5 = \underline{\quad}$ |
|---|---|--|

| | | |
|--|--|--|
| $10 = 4 + \underline{\quad}$ $10 = 5 + \underline{\quad}$ $10 = \underline{\quad} + 4$ $10 = \underline{\quad} + 2$ $10 = 6 + \underline{\quad}$ | $10 = 5 + \underline{\quad}$ $10 = \underline{\quad} + 1$ $10 = \underline{\quad} + 5$ $10 = \underline{\quad} + 6$ $10 = 2 + \underline{\quad}$ | $10 = 9 + \underline{\quad}$ $10 = \underline{\quad} + 3$ $10 = 3 + \underline{\quad}$ $10 = \underline{\quad} + 8$ $10 = 7 + \underline{\quad}$ |
|--|--|--|

| | | |
|--|--|--|
| $13 = 4 + \underline{\quad}$ $14 = 5 + \underline{\quad}$ $11 = \underline{\quad} + 4$ | $12 = 5 + \underline{\quad}$ $14 = \underline{\quad} + 7$ $16 = \underline{\quad} + 8$ | $12 = \underline{\quad} + \underline{\quad}$ $17 = \underline{\quad} + \underline{\quad}$ $18 = \underline{\quad} + \underline{\quad}$ |
|--|--|--|

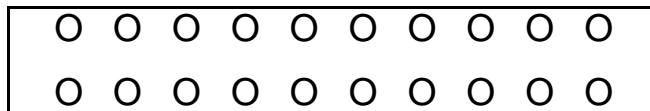

| | |
|-----------------------------|-----------------------------|
| 3 + 2 + 1 = <u> </u> | 4 + 1 + 1 = <u> </u> |
| 1 + 3 + 1 = <u> </u> | 1 + 3 + 3 = <u> </u> |
| 2 + 2 + 3 = <u> </u> | 2 + 4 + 1 = <u> </u> |
| 2 + 1 + 3 = <u> </u> | 5 + 2 + 1 = <u> </u> |
| 4 + 2 + 1 = <u> </u> | 2 + 3 + 2 = <u> </u> |
| 4 + 2 + 3 = <u> </u> | 3 + 3 + 3 = <u> </u> |
| 3 + 2 + 2 = <u> </u> | 2 + 2 + 2 = <u> </u> |
| 1 + 1 + 1 = <u> </u> | 1 + 2 + 2 = <u> </u> |
| 2 + 1 + 3 = <u> </u> | 4 + 1 + 2 = <u> </u> |
| 4 + 2 + 1 = <u> </u> | 2 + 2 + 4 = <u> </u> |
| 7 + 1 + 1 = <u> </u> | 3 + 3 + 1 = <u> </u> |
| 6 + 2 + 1 = <u> </u> | 3 + 2 + 3 = <u> </u> |
| 2 + 5 + 1 = <u> </u> | 5 + 3 + 2 = <u> </u> |
| 2 + 6 + 1 = <u> </u> | 6 + 1 + 3 = <u> </u> |
| 4 + 3 + 2 = <u> </u> | 4 + 2 + 2 = <u> </u> |

| | |
|------------------------------|------------------------------|
| 4 + 3 + <u> </u> = 10 | 3 + 5 + <u> </u> = 11 |
| 3 + 3 + <u> </u> = 10 | 2 + 3 + <u> </u> = 11 |
| 1 + 2 + <u> </u> = 10 | 1 + 3 + <u> </u> = 11 |
| 3 + 4 + <u> </u> = 10 | 3 + 2 + <u> </u> = 11 |
| 3 + 1 + <u> </u> = 10 | 4 + 2 + <u> </u> = 11 |
| 1 + 1 + <u> </u> = 10 | 5 + 2 + <u> </u> = 11 |

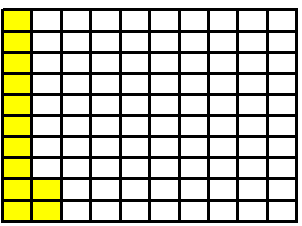

| | |
|--------|-------|
| 10-ere | 1-ere |
| 1 | 2 |

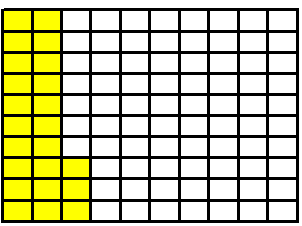

| | |
|--------|-------|
| 10-ere | 1-ere |
| | |

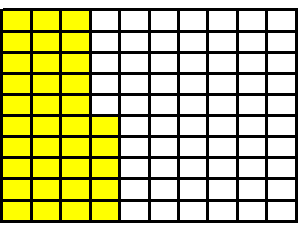

| | |
|--------|-------|
| 10-ere | 1-ere |
| | |

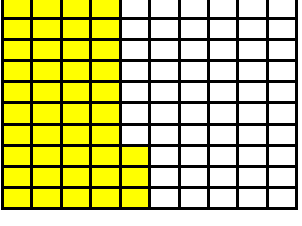

| | |
|--------|-------|
| 10-ere | 1-ere |
| | |

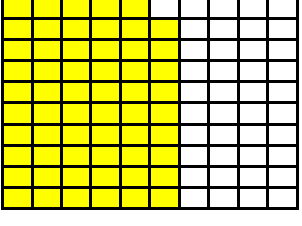

| | |
|--------|-------|
| 10-ere | 1-ere |
| | |

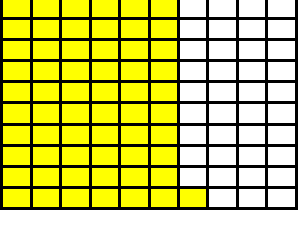

| | |
|--------|-------|
| 10-ere | 1-ere |
| | |

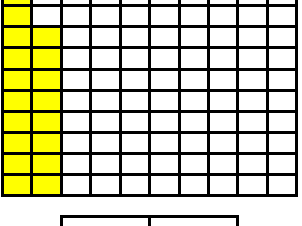

| | |
|--------|-------|
| 10-ere | 1-ere |
| | |

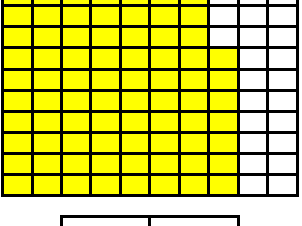

| | |
|--------|-------|
| 10-ere | 1-ere |
| | |

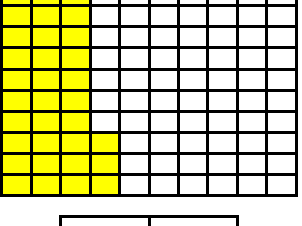

| | |
|--------|-------|
| 10-ere | 1-ere |
| | |

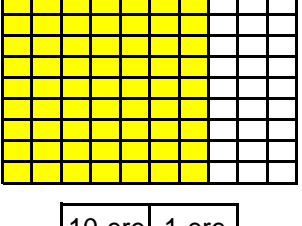

| | |
|--------|-------|
| 10-ere | 1-ere |
| | |

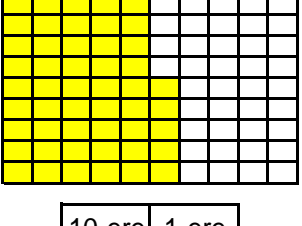

| | |
|--------|-------|
| 10-ere | 1-ere |
| | |

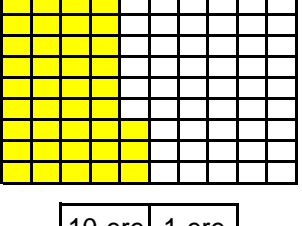

| | |
|--------|-------|
| 10-ere | 1-ere |
| | |

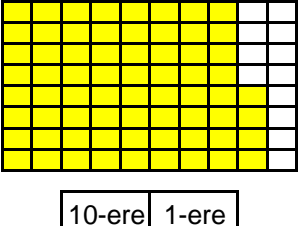

| | |
|--------|-------|
| 10-ere | 1-ere |
| | |

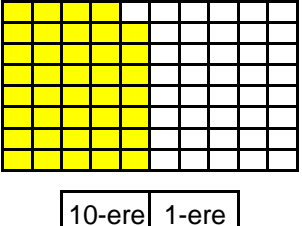

| | |
|--------|-------|
| 10-ere | 1-ere |
| | |

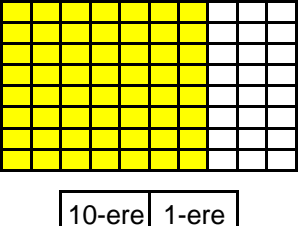

| | |
|--------|-------|
| 10-ere | 1-ere |
| | |

| | |
|--------|-------|
| 10-ere | 1-ere |
| 2 | 2 |

| | |
|--------|-------|
| 10-ere | 1-ere |
| 3 | 5 |

| | |
|--------|-------|
| 10-ere | 1-ere |
| 5 | 3 |

| | |
|--------|-------|
| 10-ere | 1-ere |
| 6 | 9 |

| | |
|--------|-------|
| 10-ere | 1-ere |
| 7 | 7 |

| | |
|--------|-------|
| 10-ere | 1-ere |
| 1 | 3 |

| | |
|--------|-------|
| 10-ere | 1-ere |
| 8 | 1 |

| | |
|--------|-------|
| 10-ere | 1-ere |
| 4 | 9 |

| | |
|--------|-------|
| 10-ere | 1-ere |
| 8 | 6 |

Lav selv

| | |
|--------|-------|
| 10-ere | 1-ere |
| | |

Lav selv

| | |
|--------|-------|
| 10-ere | 1-ere |
| | |

Lav selv

| | |
|--------|-------|
| 10-ere | 1-ere |
| | |

Lav selv

| | |
|--------|-------|
| 10-ere | 1-ere |
| | |

Lav selv

| | |
|--------|-------|
| 10-ere | 1-ere |
| | |



Lav selv

| | |
|--------|-------|
| 10-ere | 1-ere |
| | |

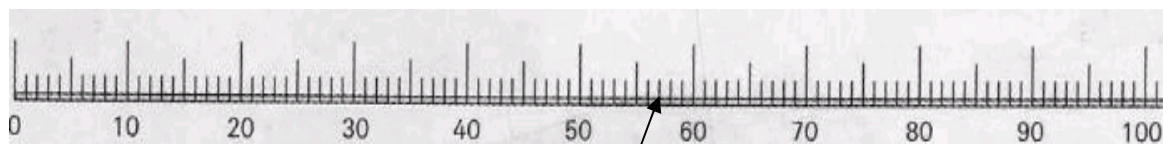
Tegn pile til det rigtige sted på tallinjen



- 9
- 16
- 23
- 34
- 43
- 57
- 66
- 79
- 87
- 96

| | | |
|--|--|--|
|  _____ |  _____ |  _____ |
|--|--|--|

| | | |
|--|--|--|
|  _____ |  _____ |  _____ |
|--|--|--|

| | | |
|--|--|--|
|  _____ |  _____ |  _____ |
|--|--|--|

| | | |
|--|--|--|
|  _____ |  _____ |  _____ |
|--|--|--|

| | | |
|--|--|--|
|  _____ |  _____ |  _____ |
|--|--|--|

| | | | | | | | | | | | | | | | | | | | | | | | | | | | | | | | | | | | | | | | | | | | | | | | | | | | | | | |
|---|---|---|---|---|---|---|--|--|---|--|--|--|---|--|--|--|---|---|---|---|---|----|--|--|--|----|--|--|--|----|--|--|--|--|---|---|---|---|---|----|--|--|--|--|----|--|--|--|--|----|--|--|--|--|
| <table border="1" style="width: 100%; border-collapse: collapse; text-align: center;"> <tr><td style="padding: 2px 5px;">+</td><td style="padding: 2px 5px;">1</td><td style="padding: 2px 5px;">2</td><td style="padding: 2px 5px;">3</td></tr> <tr><td style="padding: 2px 5px;">2</td><td style="padding: 2px 5px;">3</td><td style="padding: 2px 5px;"></td><td style="padding: 2px 5px;"></td></tr> <tr><td style="padding: 2px 5px;">3</td><td style="padding: 2px 5px;"></td><td style="padding: 2px 5px;"></td><td style="padding: 2px 5px;"></td></tr> <tr><td style="padding: 2px 5px;">4</td><td style="padding: 2px 5px;"></td><td style="padding: 2px 5px;"></td><td style="padding: 2px 5px;"></td></tr> </table> | + | 1 | 2 | 3 | 2 | 3 | | | 3 | | | | 4 | | | | <table border="1" style="width: 100%; border-collapse: collapse; text-align: center;"> <tr><td style="padding: 2px 5px;">+</td><td style="padding: 2px 5px;">4</td><td style="padding: 2px 5px;">5</td><td style="padding: 2px 5px;">1</td></tr> <tr><td style="padding: 2px 5px;">3</td><td style="padding: 2px 5px;"></td><td style="padding: 2px 5px;"></td><td style="padding: 2px 5px;"></td></tr> <tr><td style="padding: 2px 5px;">5</td><td style="padding: 2px 5px;"></td><td style="padding: 2px 5px;"></td><td style="padding: 2px 5px;"></td></tr> <tr><td style="padding: 2px 5px;">6</td><td style="padding: 2px 5px;"></td><td style="padding: 2px 5px;"></td><td style="padding: 2px 5px;"></td></tr> </table> | + | 4 | 5 | 1 | 3 | | | | 5 | | | | 6 | | | | <table border="1" style="width: 100%; border-collapse: collapse; text-align: center;"> <tr><td style="padding: 2px 5px;">+</td><td style="padding: 2px 5px;">3</td><td style="padding: 2px 5px;">2</td><td style="padding: 2px 5px;">6</td><td style="padding: 2px 5px;">5</td></tr> <tr><td style="padding: 2px 5px;">2</td><td style="padding: 2px 5px;"></td><td style="padding: 2px 5px;"></td><td style="padding: 2px 5px;"></td><td style="padding: 2px 5px;"></td></tr> <tr><td style="padding: 2px 5px;">3</td><td style="padding: 2px 5px;"></td><td style="padding: 2px 5px;"></td><td style="padding: 2px 5px;"></td><td style="padding: 2px 5px;"></td></tr> <tr><td style="padding: 2px 5px;">6</td><td style="padding: 2px 5px;"></td><td style="padding: 2px 5px;"></td><td style="padding: 2px 5px;"></td><td style="padding: 2px 5px;"></td></tr> </table> | + | 3 | 2 | 6 | 5 | 2 | | | | | 3 | | | | | 6 | | | | |
| + | 1 | 2 | 3 | | | | | | | | | | | | | | | | | | | | | | | | | | | | | | | | | | | | | | | | | | | | | | | | | | | |
| 2 | 3 | | | | | | | | | | | | | | | | | | | | | | | | | | | | | | | | | | | | | | | | | | | | | | | | | | | | | |
| 3 | | | | | | | | | | | | | | | | | | | | | | | | | | | | | | | | | | | | | | | | | | | | | | | | | | | | | | |
| 4 | | | | | | | | | | | | | | | | | | | | | | | | | | | | | | | | | | | | | | | | | | | | | | | | | | | | | | |
| + | 4 | 5 | 1 | | | | | | | | | | | | | | | | | | | | | | | | | | | | | | | | | | | | | | | | | | | | | | | | | | | |
| 3 | | | | | | | | | | | | | | | | | | | | | | | | | | | | | | | | | | | | | | | | | | | | | | | | | | | | | | |
| 5 | | | | | | | | | | | | | | | | | | | | | | | | | | | | | | | | | | | | | | | | | | | | | | | | | | | | | | |
| 6 | | | | | | | | | | | | | | | | | | | | | | | | | | | | | | | | | | | | | | | | | | | | | | | | | | | | | | |
| + | 3 | 2 | 6 | 5 | | | | | | | | | | | | | | | | | | | | | | | | | | | | | | | | | | | | | | | | | | | | | | | | | | |
| 2 | | | | | | | | | | | | | | | | | | | | | | | | | | | | | | | | | | | | | | | | | | | | | | | | | | | | | | |
| 3 | | | | | | | | | | | | | | | | | | | | | | | | | | | | | | | | | | | | | | | | | | | | | | | | | | | | | | |
| 6 | | | | | | | | | | | | | | | | | | | | | | | | | | | | | | | | | | | | | | | | | | | | | | | | | | | | | | |
| <table border="1" style="width: 100%; border-collapse: collapse; text-align: center;"> <tr><td style="padding: 2px 5px;">-</td><td style="padding: 2px 5px;">1</td><td style="padding: 2px 5px;">2</td><td style="padding: 2px 5px;">3</td></tr> <tr><td style="padding: 2px 5px;">6</td><td style="padding: 2px 5px;"></td><td style="padding: 2px 5px;"></td><td style="padding: 2px 5px;"></td></tr> <tr><td style="padding: 2px 5px;">7</td><td style="padding: 2px 5px;"></td><td style="padding: 2px 5px;"></td><td style="padding: 2px 5px;"></td></tr> <tr><td style="padding: 2px 5px;">8</td><td style="padding: 2px 5px;"></td><td style="padding: 2px 5px;"></td><td style="padding: 2px 5px;"></td></tr> </table> | - | 1 | 2 | 3 | 6 | | | | 7 | | | | 8 | | | | <table border="1" style="width: 100%; border-collapse: collapse; text-align: center;"> <tr><td style="padding: 2px 5px;">-</td><td style="padding: 2px 5px;">2</td><td style="padding: 2px 5px;">3</td><td style="padding: 2px 5px;">4</td></tr> <tr><td style="padding: 2px 5px;">7</td><td style="padding: 2px 5px;"></td><td style="padding: 2px 5px;"></td><td style="padding: 2px 5px;"></td></tr> <tr><td style="padding: 2px 5px;">8</td><td style="padding: 2px 5px;"></td><td style="padding: 2px 5px;"></td><td style="padding: 2px 5px;"></td></tr> <tr><td style="padding: 2px 5px;">9</td><td style="padding: 2px 5px;"></td><td style="padding: 2px 5px;"></td><td style="padding: 2px 5px;"></td></tr> </table> | - | 2 | 3 | 4 | 7 | | | | 8 | | | | 9 | | | | <table border="1" style="width: 100%; border-collapse: collapse; text-align: center;"> <tr><td style="padding: 2px 5px;">-</td><td style="padding: 2px 5px;">2</td><td style="padding: 2px 5px;">3</td><td style="padding: 2px 5px;">4</td><td style="padding: 2px 5px;">5</td></tr> <tr><td style="padding: 2px 5px;">6</td><td style="padding: 2px 5px;"></td><td style="padding: 2px 5px;"></td><td style="padding: 2px 5px;"></td><td style="padding: 2px 5px;"></td></tr> <tr><td style="padding: 2px 5px;">7</td><td style="padding: 2px 5px;"></td><td style="padding: 2px 5px;"></td><td style="padding: 2px 5px;"></td><td style="padding: 2px 5px;"></td></tr> <tr><td style="padding: 2px 5px;">10</td><td style="padding: 2px 5px;"></td><td style="padding: 2px 5px;"></td><td style="padding: 2px 5px;"></td><td style="padding: 2px 5px;"></td></tr> </table> | - | 2 | 3 | 4 | 5 | 6 | | | | | 7 | | | | | 10 | | | | |
| - | 1 | 2 | 3 | | | | | | | | | | | | | | | | | | | | | | | | | | | | | | | | | | | | | | | | | | | | | | | | | | | |
| 6 | | | | | | | | | | | | | | | | | | | | | | | | | | | | | | | | | | | | | | | | | | | | | | | | | | | | | | |
| 7 | | | | | | | | | | | | | | | | | | | | | | | | | | | | | | | | | | | | | | | | | | | | | | | | | | | | | | |
| 8 | | | | | | | | | | | | | | | | | | | | | | | | | | | | | | | | | | | | | | | | | | | | | | | | | | | | | | |
| - | 2 | 3 | 4 | | | | | | | | | | | | | | | | | | | | | | | | | | | | | | | | | | | | | | | | | | | | | | | | | | | |
| 7 | | | | | | | | | | | | | | | | | | | | | | | | | | | | | | | | | | | | | | | | | | | | | | | | | | | | | | |
| 8 | | | | | | | | | | | | | | | | | | | | | | | | | | | | | | | | | | | | | | | | | | | | | | | | | | | | | | |
| 9 | | | | | | | | | | | | | | | | | | | | | | | | | | | | | | | | | | | | | | | | | | | | | | | | | | | | | | |
| - | 2 | 3 | 4 | 5 | | | | | | | | | | | | | | | | | | | | | | | | | | | | | | | | | | | | | | | | | | | | | | | | | | |
| 6 | | | | | | | | | | | | | | | | | | | | | | | | | | | | | | | | | | | | | | | | | | | | | | | | | | | | | | |
| 7 | | | | | | | | | | | | | | | | | | | | | | | | | | | | | | | | | | | | | | | | | | | | | | | | | | | | | | |
| 10 | | | | | | | | | | | | | | | | | | | | | | | | | | | | | | | | | | | | | | | | | | | | | | | | | | | | | | |
| <table border="1" style="width: 100%; border-collapse: collapse; text-align: center;"> <tr><td style="padding: 2px 5px;">+</td><td style="padding: 2px 5px;">3</td><td style="padding: 2px 5px;">4</td><td style="padding: 2px 5px;">6</td></tr> <tr><td style="padding: 2px 5px;">4</td><td style="padding: 2px 5px;"></td><td style="padding: 2px 5px;"></td><td style="padding: 2px 5px;"></td></tr> <tr><td style="padding: 2px 5px;">5</td><td style="padding: 2px 5px;"></td><td style="padding: 2px 5px;"></td><td style="padding: 2px 5px;"></td></tr> <tr><td style="padding: 2px 5px;">6</td><td style="padding: 2px 5px;"></td><td style="padding: 2px 5px;"></td><td style="padding: 2px 5px;"></td></tr> </table> | + | 3 | 4 | 6 | 4 | | | | 5 | | | | 6 | | | | <table border="1" style="width: 100%; border-collapse: collapse; text-align: center;"> <tr><td style="padding: 2px 5px;">+</td><td style="padding: 2px 5px;">1</td><td style="padding: 2px 5px;">2</td><td style="padding: 2px 5px;">3</td></tr> <tr><td style="padding: 2px 5px;">5</td><td style="padding: 2px 5px;"></td><td style="padding: 2px 5px;"></td><td style="padding: 2px 5px;"></td></tr> <tr><td style="padding: 2px 5px;">3</td><td style="padding: 2px 5px;"></td><td style="padding: 2px 5px;"></td><td style="padding: 2px 5px;"></td></tr> <tr><td style="padding: 2px 5px;">1</td><td style="padding: 2px 5px;"></td><td style="padding: 2px 5px;"></td><td style="padding: 2px 5px;"></td></tr> </table> | + | 1 | 2 | 3 | 5 | | | | 3 | | | | 1 | | | | <table border="1" style="width: 100%; border-collapse: collapse; text-align: center;"> <tr><td style="padding: 2px 5px;">+</td><td style="padding: 2px 5px;">1</td><td style="padding: 2px 5px;">3</td><td style="padding: 2px 5px;">5</td><td style="padding: 2px 5px;">6</td></tr> <tr><td style="padding: 2px 5px;">2</td><td style="padding: 2px 5px;"></td><td style="padding: 2px 5px;"></td><td style="padding: 2px 5px;"></td><td style="padding: 2px 5px;"></td></tr> <tr><td style="padding: 2px 5px;">4</td><td style="padding: 2px 5px;"></td><td style="padding: 2px 5px;"></td><td style="padding: 2px 5px;"></td><td style="padding: 2px 5px;"></td></tr> <tr><td style="padding: 2px 5px;">6</td><td style="padding: 2px 5px;"></td><td style="padding: 2px 5px;"></td><td style="padding: 2px 5px;"></td><td style="padding: 2px 5px;"></td></tr> </table> | + | 1 | 3 | 5 | 6 | 2 | | | | | 4 | | | | | 6 | | | | |
| + | 3 | 4 | 6 | | | | | | | | | | | | | | | | | | | | | | | | | | | | | | | | | | | | | | | | | | | | | | | | | | | |
| 4 | | | | | | | | | | | | | | | | | | | | | | | | | | | | | | | | | | | | | | | | | | | | | | | | | | | | | | |
| 5 | | | | | | | | | | | | | | | | | | | | | | | | | | | | | | | | | | | | | | | | | | | | | | | | | | | | | | |
| 6 | | | | | | | | | | | | | | | | | | | | | | | | | | | | | | | | | | | | | | | | | | | | | | | | | | | | | | |
| + | 1 | 2 | 3 | | | | | | | | | | | | | | | | | | | | | | | | | | | | | | | | | | | | | | | | | | | | | | | | | | | |
| 5 | | | | | | | | | | | | | | | | | | | | | | | | | | | | | | | | | | | | | | | | | | | | | | | | | | | | | | |
| 3 | | | | | | | | | | | | | | | | | | | | | | | | | | | | | | | | | | | | | | | | | | | | | | | | | | | | | | |
| 1 | | | | | | | | | | | | | | | | | | | | | | | | | | | | | | | | | | | | | | | | | | | | | | | | | | | | | | |
| + | 1 | 3 | 5 | 6 | | | | | | | | | | | | | | | | | | | | | | | | | | | | | | | | | | | | | | | | | | | | | | | | | | |
| 2 | | | | | | | | | | | | | | | | | | | | | | | | | | | | | | | | | | | | | | | | | | | | | | | | | | | | | | |
| 4 | | | | | | | | | | | | | | | | | | | | | | | | | | | | | | | | | | | | | | | | | | | | | | | | | | | | | | |
| 6 | | | | | | | | | | | | | | | | | | | | | | | | | | | | | | | | | | | | | | | | | | | | | | | | | | | | | | |
| <table border="1" style="width: 100%; border-collapse: collapse; text-align: center;"> <tr><td style="padding: 2px 5px;">-</td><td style="padding: 2px 5px;">1</td><td style="padding: 2px 5px;">2</td><td style="padding: 2px 5px;">3</td></tr> <tr><td style="padding: 2px 5px;">4</td><td style="padding: 2px 5px;"></td><td style="padding: 2px 5px;"></td><td style="padding: 2px 5px;"></td></tr> <tr><td style="padding: 2px 5px;">5</td><td style="padding: 2px 5px;"></td><td style="padding: 2px 5px;"></td><td style="padding: 2px 5px;"></td></tr> <tr><td style="padding: 2px 5px;">6</td><td style="padding: 2px 5px;"></td><td style="padding: 2px 5px;"></td><td style="padding: 2px 5px;"></td></tr> </table> | - | 1 | 2 | 3 | 4 | | | | 5 | | | | 6 | | | | <table border="1" style="width: 100%; border-collapse: collapse; text-align: center;"> <tr><td style="padding: 2px 5px;">-</td><td style="padding: 2px 5px;">1</td><td style="padding: 2px 5px;">2</td><td style="padding: 2px 5px;">3</td></tr> <tr><td style="padding: 2px 5px;">7</td><td style="padding: 2px 5px;"></td><td style="padding: 2px 5px;"></td><td style="padding: 2px 5px;"></td></tr> <tr><td style="padding: 2px 5px;">8</td><td style="padding: 2px 5px;"></td><td style="padding: 2px 5px;"></td><td style="padding: 2px 5px;"></td></tr> <tr><td style="padding: 2px 5px;">9</td><td style="padding: 2px 5px;"></td><td style="padding: 2px 5px;"></td><td style="padding: 2px 5px;"></td></tr> </table> | - | 1 | 2 | 3 | 7 | | | | 8 | | | | 9 | | | | <table border="1" style="width: 100%; border-collapse: collapse; text-align: center;"> <tr><td style="padding: 2px 5px;">-</td><td style="padding: 2px 5px;">1</td><td style="padding: 2px 5px;">2</td><td style="padding: 2px 5px;">3</td><td style="padding: 2px 5px;">4</td></tr> <tr><td style="padding: 2px 5px;">10</td><td style="padding: 2px 5px;"></td><td style="padding: 2px 5px;"></td><td style="padding: 2px 5px;"></td><td style="padding: 2px 5px;"></td></tr> <tr><td style="padding: 2px 5px;">11</td><td style="padding: 2px 5px;"></td><td style="padding: 2px 5px;"></td><td style="padding: 2px 5px;"></td><td style="padding: 2px 5px;"></td></tr> <tr><td style="padding: 2px 5px;">12</td><td style="padding: 2px 5px;"></td><td style="padding: 2px 5px;"></td><td style="padding: 2px 5px;"></td><td style="padding: 2px 5px;"></td></tr> </table> | - | 1 | 2 | 3 | 4 | 10 | | | | | 11 | | | | | 12 | | | | |
| - | 1 | 2 | 3 | | | | | | | | | | | | | | | | | | | | | | | | | | | | | | | | | | | | | | | | | | | | | | | | | | | |
| 4 | | | | | | | | | | | | | | | | | | | | | | | | | | | | | | | | | | | | | | | | | | | | | | | | | | | | | | |
| 5 | | | | | | | | | | | | | | | | | | | | | | | | | | | | | | | | | | | | | | | | | | | | | | | | | | | | | | |
| 6 | | | | | | | | | | | | | | | | | | | | | | | | | | | | | | | | | | | | | | | | | | | | | | | | | | | | | | |
| - | 1 | 2 | 3 | | | | | | | | | | | | | | | | | | | | | | | | | | | | | | | | | | | | | | | | | | | | | | | | | | | |
| 7 | | | | | | | | | | | | | | | | | | | | | | | | | | | | | | | | | | | | | | | | | | | | | | | | | | | | | | |
| 8 | | | | | | | | | | | | | | | | | | | | | | | | | | | | | | | | | | | | | | | | | | | | | | | | | | | | | | |
| 9 | | | | | | | | | | | | | | | | | | | | | | | | | | | | | | | | | | | | | | | | | | | | | | | | | | | | | | |
| - | 1 | 2 | 3 | 4 | | | | | | | | | | | | | | | | | | | | | | | | | | | | | | | | | | | | | | | | | | | | | | | | | | |
| 10 | | | | | | | | | | | | | | | | | | | | | | | | | | | | | | | | | | | | | | | | | | | | | | | | | | | | | | |
| 11 | | | | | | | | | | | | | | | | | | | | | | | | | | | | | | | | | | | | | | | | | | | | | | | | | | | | | | |
| 12 | | | | | | | | | | | | | | | | | | | | | | | | | | | | | | | | | | | | | | | | | | | | | | | | | | | | | | |
| <table border="1" style="width: 100%; border-collapse: collapse; text-align: center;"> <tr><td style="padding: 2px 5px;">+</td><td style="padding: 2px 5px;">4</td><td style="padding: 2px 5px;">5</td><td style="padding: 2px 5px;">6</td></tr> <tr><td style="padding: 2px 5px;">4</td><td style="padding: 2px 5px;"></td><td style="padding: 2px 5px;"></td><td style="padding: 2px 5px;"></td></tr> <tr><td style="padding: 2px 5px;">5</td><td style="padding: 2px 5px;"></td><td style="padding: 2px 5px;"></td><td style="padding: 2px 5px;"></td></tr> <tr><td style="padding: 2px 5px;">6</td><td style="padding: 2px 5px;"></td><td style="padding: 2px 5px;"></td><td style="padding: 2px 5px;"></td></tr> </table> | + | 4 | 5 | 6 | 4 | | | | 5 | | | | 6 | | | | <table border="1" style="width: 100%; border-collapse: collapse; text-align: center;"> <tr><td style="padding: 2px 5px;">+</td><td style="padding: 2px 5px;">1</td><td style="padding: 2px 5px;">2</td><td style="padding: 2px 5px;">3</td></tr> <tr><td style="padding: 2px 5px;">10</td><td style="padding: 2px 5px;"></td><td style="padding: 2px 5px;"></td><td style="padding: 2px 5px;"></td></tr> <tr><td style="padding: 2px 5px;">11</td><td style="padding: 2px 5px;"></td><td style="padding: 2px 5px;"></td><td style="padding: 2px 5px;"></td></tr> <tr><td style="padding: 2px 5px;">12</td><td style="padding: 2px 5px;"></td><td style="padding: 2px 5px;"></td><td style="padding: 2px 5px;"></td></tr> </table> | + | 1 | 2 | 3 | 10 | | | | 11 | | | | 12 | | | | <table border="1" style="width: 100%; border-collapse: collapse; text-align: center;"> <tr><td style="padding: 2px 5px;">+</td><td style="padding: 2px 5px;">4</td><td style="padding: 2px 5px;">5</td><td style="padding: 2px 5px;">6</td><td style="padding: 2px 5px;">7</td></tr> <tr><td style="padding: 2px 5px;">10</td><td style="padding: 2px 5px;"></td><td style="padding: 2px 5px;"></td><td style="padding: 2px 5px;"></td><td style="padding: 2px 5px;"></td></tr> <tr><td style="padding: 2px 5px;">11</td><td style="padding: 2px 5px;"></td><td style="padding: 2px 5px;"></td><td style="padding: 2px 5px;"></td><td style="padding: 2px 5px;"></td></tr> <tr><td style="padding: 2px 5px;">12</td><td style="padding: 2px 5px;"></td><td style="padding: 2px 5px;"></td><td style="padding: 2px 5px;"></td><td style="padding: 2px 5px;"></td></tr> </table> | + | 4 | 5 | 6 | 7 | 10 | | | | | 11 | | | | | 12 | | | | |
| + | 4 | 5 | 6 | | | | | | | | | | | | | | | | | | | | | | | | | | | | | | | | | | | | | | | | | | | | | | | | | | | |
| 4 | | | | | | | | | | | | | | | | | | | | | | | | | | | | | | | | | | | | | | | | | | | | | | | | | | | | | | |
| 5 | | | | | | | | | | | | | | | | | | | | | | | | | | | | | | | | | | | | | | | | | | | | | | | | | | | | | | |
| 6 | | | | | | | | | | | | | | | | | | | | | | | | | | | | | | | | | | | | | | | | | | | | | | | | | | | | | | |
| + | 1 | 2 | 3 | | | | | | | | | | | | | | | | | | | | | | | | | | | | | | | | | | | | | | | | | | | | | | | | | | | |
| 10 | | | | | | | | | | | | | | | | | | | | | | | | | | | | | | | | | | | | | | | | | | | | | | | | | | | | | | |
| 11 | | | | | | | | | | | | | | | | | | | | | | | | | | | | | | | | | | | | | | | | | | | | | | | | | | | | | | |
| 12 | | | | | | | | | | | | | | | | | | | | | | | | | | | | | | | | | | | | | | | | | | | | | | | | | | | | | | |
| + | 4 | 5 | 6 | 7 | | | | | | | | | | | | | | | | | | | | | | | | | | | | | | | | | | | | | | | | | | | | | | | | | | |
| 10 | | | | | | | | | | | | | | | | | | | | | | | | | | | | | | | | | | | | | | | | | | | | | | | | | | | | | | |
| 11 | | | | | | | | | | | | | | | | | | | | | | | | | | | | | | | | | | | | | | | | | | | | | | | | | | | | | | |
| 12 | | | | | | | | | | | | | | | | | | | | | | | | | | | | | | | | | | | | | | | | | | | | | | | | | | | | | | |
| <table border="1" style="width: 100%; border-collapse: collapse; text-align: center;"> <tr><td style="padding: 2px 5px;">-</td><td style="padding: 2px 5px;">4</td><td style="padding: 2px 5px;">5</td><td style="padding: 2px 5px;">6</td></tr> <tr><td style="padding: 2px 5px;">7</td><td style="padding: 2px 5px;"></td><td style="padding: 2px 5px;"></td><td style="padding: 2px 5px;"></td></tr> <tr><td style="padding: 2px 5px;">8</td><td style="padding: 2px 5px;"></td><td style="padding: 2px 5px;"></td><td style="padding: 2px 5px;"></td></tr> <tr><td style="padding: 2px 5px;">9</td><td style="padding: 2px 5px;"></td><td style="padding: 2px 5px;"></td><td style="padding: 2px 5px;"></td></tr> </table> | - | 4 | 5 | 6 | 7 | | | | 8 | | | | 9 | | | | <table border="1" style="width: 100%; border-collapse: collapse; text-align: center;"> <tr><td style="padding: 2px 5px;">-</td><td style="padding: 2px 5px;">2</td><td style="padding: 2px 5px;">4</td><td style="padding: 2px 5px;">6</td></tr> <tr><td style="padding: 2px 5px;">12</td><td style="padding: 2px 5px;"></td><td style="padding: 2px 5px;"></td><td style="padding: 2px 5px;"></td></tr> <tr><td style="padding: 2px 5px;">13</td><td style="padding: 2px 5px;"></td><td style="padding: 2px 5px;"></td><td style="padding: 2px 5px;"></td></tr> <tr><td style="padding: 2px 5px;">14</td><td style="padding: 2px 5px;"></td><td style="padding: 2px 5px;"></td><td style="padding: 2px 5px;"></td></tr> </table> | - | 2 | 4 | 6 | 12 | | | | 13 | | | | 14 | | | | <table border="1" style="width: 100%; border-collapse: collapse; text-align: center;"> <tr><td style="padding: 2px 5px;">-</td><td style="padding: 2px 5px;">1</td><td style="padding: 2px 5px;">2</td><td style="padding: 2px 5px;">3</td><td style="padding: 2px 5px;">4</td></tr> <tr><td style="padding: 2px 5px;">14</td><td style="padding: 2px 5px;"></td><td style="padding: 2px 5px;"></td><td style="padding: 2px 5px;"></td><td style="padding: 2px 5px;"></td></tr> <tr><td style="padding: 2px 5px;">15</td><td style="padding: 2px 5px;"></td><td style="padding: 2px 5px;"></td><td style="padding: 2px 5px;"></td><td style="padding: 2px 5px;"></td></tr> <tr><td style="padding: 2px 5px;">16</td><td style="padding: 2px 5px;"></td><td style="padding: 2px 5px;"></td><td style="padding: 2px 5px;"></td><td style="padding: 2px 5px;"></td></tr> </table> | - | 1 | 2 | 3 | 4 | 14 | | | | | 15 | | | | | 16 | | | | |
| - | 4 | 5 | 6 | | | | | | | | | | | | | | | | | | | | | | | | | | | | | | | | | | | | | | | | | | | | | | | | | | | |
| 7 | | | | | | | | | | | | | | | | | | | | | | | | | | | | | | | | | | | | | | | | | | | | | | | | | | | | | | |
| 8 | | | | | | | | | | | | | | | | | | | | | | | | | | | | | | | | | | | | | | | | | | | | | | | | | | | | | | |
| 9 | | | | | | | | | | | | | | | | | | | | | | | | | | | | | | | | | | | | | | | | | | | | | | | | | | | | | | |
| - | 2 | 4 | 6 | | | | | | | | | | | | | | | | | | | | | | | | | | | | | | | | | | | | | | | | | | | | | | | | | | | |
| 12 | | | | | | | | | | | | | | | | | | | | | | | | | | | | | | | | | | | | | | | | | | | | | | | | | | | | | | |
| 13 | | | | | | | | | | | | | | | | | | | | | | | | | | | | | | | | | | | | | | | | | | | | | | | | | | | | | | |
| 14 | | | | | | | | | | | | | | | | | | | | | | | | | | | | | | | | | | | | | | | | | | | | | | | | | | | | | | |
| - | 1 | 2 | 3 | 4 | | | | | | | | | | | | | | | | | | | | | | | | | | | | | | | | | | | | | | | | | | | | | | | | | | |
| 14 | | | | | | | | | | | | | | | | | | | | | | | | | | | | | | | | | | | | | | | | | | | | | | | | | | | | | | |
| 15 | | | | | | | | | | | | | | | | | | | | | | | | | | | | | | | | | | | | | | | | | | | | | | | | | | | | | | |
| 16 | | | | | | | | | | | | | | | | | | | | | | | | | | | | | | | | | | | | | | | | | | | | | | | | | | | | | | |

Tegn videre i rigtig rækkefølge

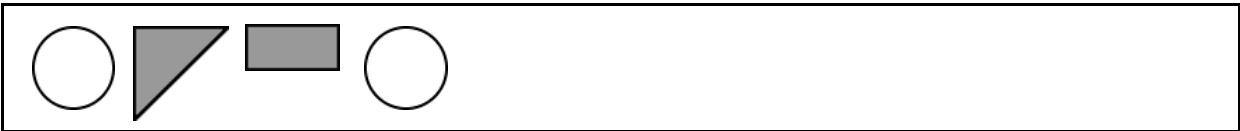

Spejl om linjen m

m

The diagram shows a vertical line labeled 'm' on a grid. To the left of the line are four shapes: a right-angled triangle with its hypotenuse on the line, a horizontal rectangle, a square, and a triangle with its base on the line. To the right of the line is a large empty area for drawing the reflections.



| | | |
|--------------------------|--------------------------|--------------------------|
| 15 - 5 = <u> </u> | 18 - 5 = <u> </u> | 23 - 2 = <u> </u> |
| 16 - 6 = <u> </u> | 15 - 4 = <u> </u> | 25 - 3 = <u> </u> |
| 19 - 9 = <u> </u> | 17 - 3 = <u> </u> | 27 - 7 = <u> </u> |
| 14 - 4 = <u> </u> | 19 - 6 = <u> </u> | 29 - 6 = <u> </u> |
| 17 - 7 = <u> </u> | 16 - 5 = <u> </u> | 28 - 5 = <u> </u> |
| 18 - 8 = <u> </u> | 14 - 3 = <u> </u> | 24 - 3 = <u> </u> |
| 13 - 3 = <u> </u> | 13 - 2 = <u> </u> | 26 - 4 = <u> </u> |

| | | |
|--------------------------|--------------------------|--------------------------|
| 20 - 5 = <u> </u> | 12 - 5 = <u> </u> | 23 - 6 = <u> </u> |
| 10 - 6 = <u> </u> | 15 - 6 = <u> </u> | 25 - 7 = <u> </u> |
| 20 - 9 = <u> </u> | 11 - 3 = <u> </u> | 27 - 8 = <u> </u> |
| 20 - 4 = <u> </u> | 12 - 6 = <u> </u> | 23 - 4 = <u> </u> |
| 10 - 7 = <u> </u> | 23 - 5 = <u> </u> | 24 - 5 = <u> </u> |
| 20 - 8 = <u> </u> | 21 - 3 = <u> </u> | 24 - 7 = <u> </u> |
| 10 - 3 = <u> </u> | 21 - 2 = <u> </u> | 26 - 7 = <u> </u> |

| | | |
|---------------------------|--------------------------|---------------------------|
| 12 - <u> </u> = 10 | 12 - <u> </u> = 8 | 23 - <u> </u> = 19 |
| 14 - <u> </u> = 10 | 14 - <u> </u> = 9 | 24 - <u> </u> = 19 |
| 15 - <u> </u> = 10 | 15 - <u> </u> = 7 | 25 - <u> </u> = 17 |
| 13 - <u> </u> = 10 | 13 - <u> </u> = 6 | 23 - <u> </u> = 16 |
| 16 - <u> </u> = 10 | 16 - <u> </u> = 9 | 21 - <u> </u> = 19 |

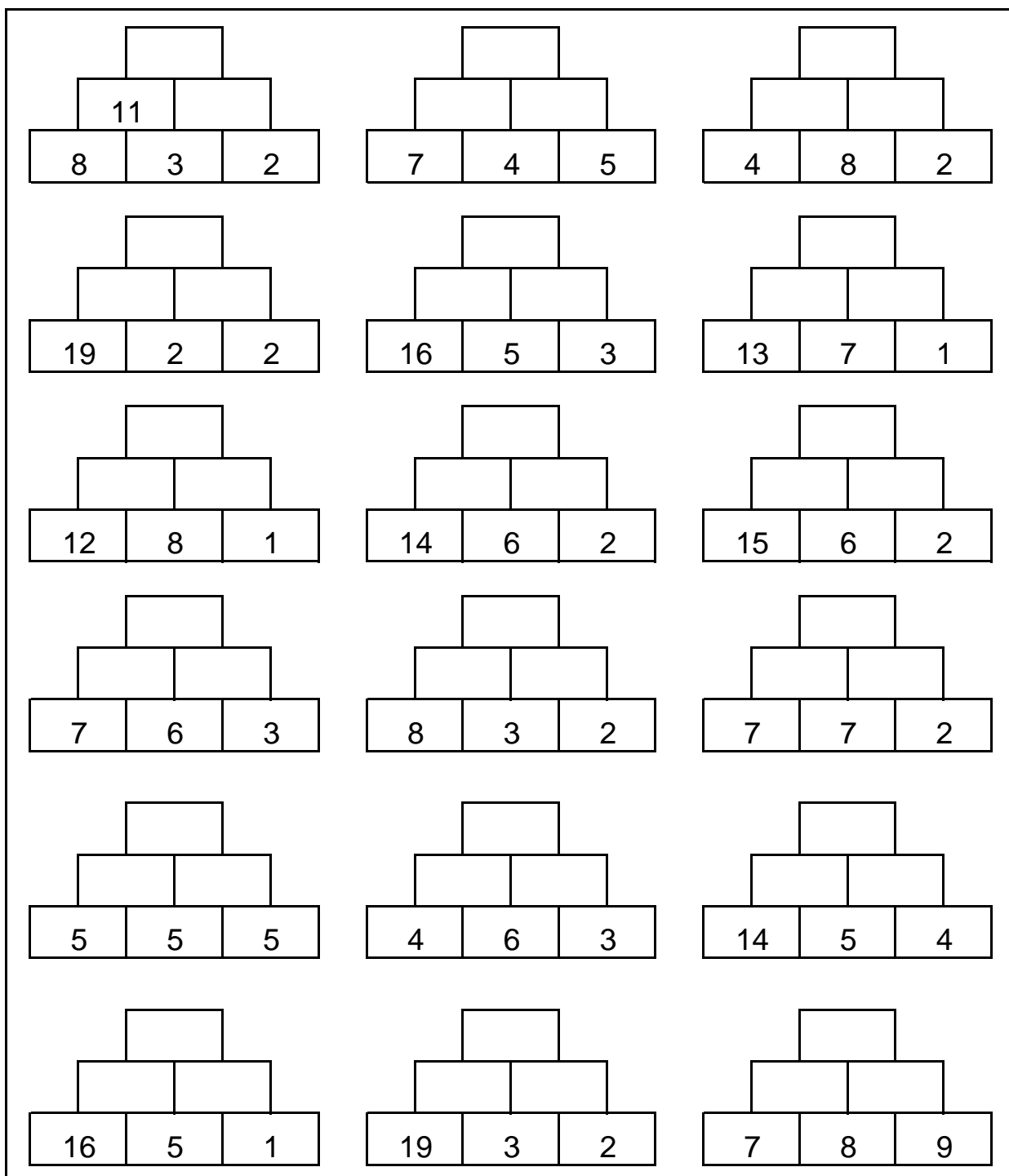
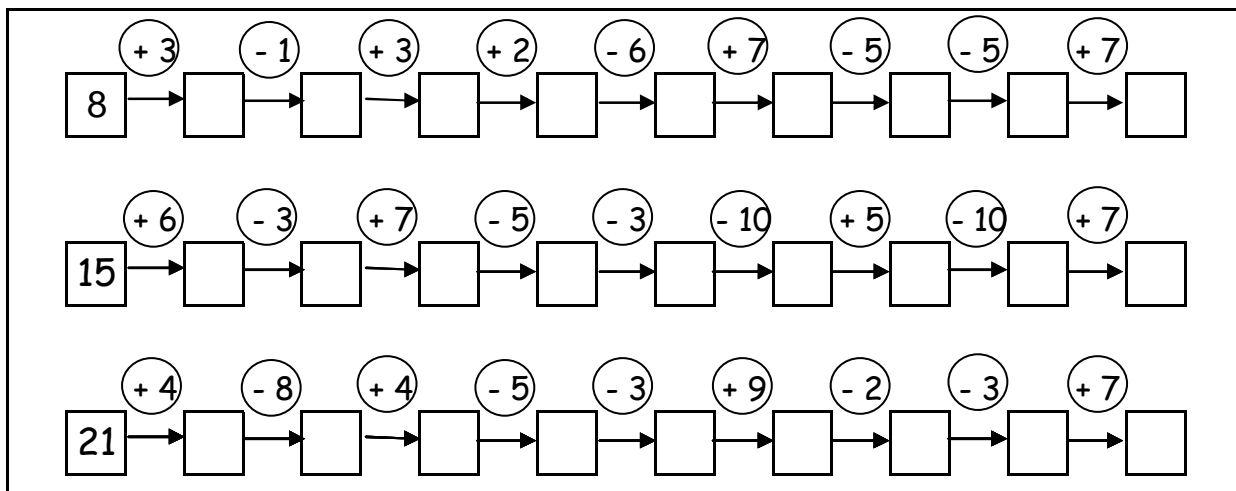

| | | | | | | | | | |
|----|----|----|----|----|----|----|----|----|----|
| 90 | 91 | 92 | 93 | 94 | 95 | 96 | 97 | 98 | 99 |
| 80 | 81 | 82 | 83 | 84 | 85 | 86 | 87 | 88 | 89 |
| 70 | 71 | 72 | 73 | 74 | 75 | 76 | 77 | 78 | 79 |
| 60 | 61 | 62 | 63 | 64 | 65 | 66 | 67 | 68 | 69 |
| 50 | 51 | 52 | 53 | 54 | 55 | 56 | 57 | 58 | 59 |
| 40 | 41 | 42 | 43 | 44 | 45 | 46 | 47 | 48 | 49 |
| 30 | 31 | 32 | 33 | 34 | 35 | 36 | 37 | 38 | 39 |
| 20 | 21 | 22 | 23 | 24 | 25 | 26 | 27 | 28 | 29 |
| 10 | 11 | 12 | 13 | 14 | 15 | 16 | 17 | 18 | 19 |
| 0 | 1 | 2 | 3 | 4 | 5 | 6 | 7 | 8 | 9 |

| | | | | | | | |
|------------|--|----|----|----|----|----|----|
| Farv grønt | | 11 | 43 | 23 | 42 | 13 | 61 |
| | | 73 | 33 | 41 | 12 | 51 | 72 |

| | | | | | | | | |
|----------|----|----|----|----|----|----|----|----|
| Farv blå | 46 | 17 | 58 | 26 | 66 | 77 | 68 | 28 |
| | 48 | 56 | 36 | 18 | 76 | 38 | 78 | 16 |

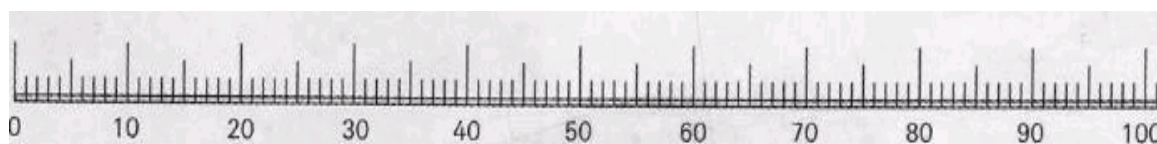

Skriv tallene i rigtig rækkefølge (mindste tal først)

| | | | | | | | | | |
|----|---|----|----|----|----|----|---|---|---|
| 19 | 3 | 11 | 17 | 15 | 16 | 13 | 7 | 9 | 8 |
| □ | □ | □ | □ | □ | □ | □ | □ | □ | □ |

| | | | | | | | | | |
|----|---|----|----|----|---|----|----|----|---|
| 28 | 2 | 33 | 35 | 23 | 9 | 18 | 10 | 14 | 3 |
| □ | □ | □ | □ | □ | □ | □ | □ | □ | □ |

| | | | | | | | | | |
|----|----|----|----|---|---|----|----|----|----|
| 27 | 22 | 39 | 33 | 2 | 7 | 13 | 25 | 35 | 31 |
| □ | □ | □ | □ | □ | □ | □ | □ | □ | □ |

Indsæt >, = eller <

| | | |
|----|---|----|
| 43 | □ | 39 |
| 28 | □ | 31 |
| 46 | □ | 46 |
| 31 | □ | 27 |
| 17 | □ | 11 |
| 49 | □ | 49 |

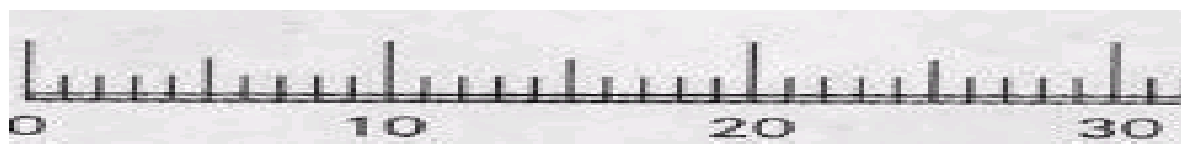

Indsæt de manglende tal

| | | | | | |
|---|---|---|---|---|---|
| $\begin{array}{r} \square \\ - 2 \\ \hline 3 \end{array}$ | $\begin{array}{r} \square \\ - 5 \\ \hline 4 \end{array}$ | $\begin{array}{r} \square \\ - 3 \\ \hline 2 \end{array}$ | $\begin{array}{r} \square \\ - 4 \\ \hline 2 \end{array}$ | $\begin{array}{r} \square \\ - 2 \\ \hline 5 \end{array}$ | $\begin{array}{r} \square \\ - 5 \\ \hline 3 \end{array}$ |
| $\begin{array}{r} 1 \square \\ - 2 \\ \hline 1 \ 1 \end{array}$ | $\begin{array}{r} 1 \square \\ - 5 \\ \hline 1 \ 2 \end{array}$ | $\begin{array}{r} 1 \square \\ - 3 \\ \hline 1 \ 6 \end{array}$ | $\begin{array}{r} 1 \square \\ - 4 \\ \hline 1 \ 2 \end{array}$ | $\begin{array}{r} 1 \square \\ - 2 \\ \hline 1 \ 5 \end{array}$ | $\begin{array}{r} 1 \square \\ - 5 \\ \hline 1 \ 3 \end{array}$ |
| $\begin{array}{r} 7 \\ - \square \\ \hline 3 \end{array}$ | $\begin{array}{r} 8 \\ - \square \\ \hline 4 \end{array}$ | $\begin{array}{r} 5 \\ - \square \\ \hline 2 \end{array}$ | $\begin{array}{r} 3 \\ - \square \\ \hline 2 \end{array}$ | $\begin{array}{r} 9 \\ - \square \\ \hline 5 \end{array}$ | $\begin{array}{r} 8 \\ - \square \\ \hline 3 \end{array}$ |
| $\begin{array}{r} 1 \ 7 \\ - \square \\ \hline 1 \ 1 \end{array}$ | $\begin{array}{r} 1 \ 6 \\ - \square \\ \hline 1 \ 3 \end{array}$ | $\begin{array}{r} 1 \ 8 \\ - \square \\ \hline 1 \ 6 \end{array}$ | $\begin{array}{r} 1 \ 4 \\ - \square \\ \hline 1 \ 2 \end{array}$ | $\begin{array}{r} 1 \ 9 \\ - \square \\ \hline 1 \ 5 \end{array}$ | $\begin{array}{r} 1 \ 8 \\ - \square \\ \hline 1 \ 3 \end{array}$ |
| $\begin{array}{r} 1 \ 7 \\ - \square \\ \hline 1 \ 3 \end{array}$ | $\begin{array}{r} 1 \ 7 \\ - \square \\ \hline 1 \ 3 \end{array}$ | $\begin{array}{r} 1 \ 5 \\ - \square \\ \hline 1 \ 3 \end{array}$ | $\begin{array}{r} 1 \ 3 \\ - \square \\ \hline 1 \ 1 \end{array}$ | $\begin{array}{r} 1 \ 9 \\ - \square \\ \hline 1 \ 5 \end{array}$ | $\begin{array}{r} 1 \ 7 \\ - \square \\ \hline 1 \ 2 \end{array}$ |
| $\begin{array}{r} 2 \ 7 \\ - \square \\ \hline 2 \ 2 \end{array}$ | $\begin{array}{r} 2 \ 6 \\ - \square \\ \hline 2 \ 4 \end{array}$ | $\begin{array}{r} 2 \ 8 \\ - \square \\ \hline 2 \ 6 \end{array}$ | $\begin{array}{r} 2 \ 5 \\ - \square \\ \hline 2 \ 2 \end{array}$ | $\begin{array}{r} 2 \ 9 \\ - \square \\ \hline 2 \ 6 \end{array}$ | $\begin{array}{r} 2 \ 7 \\ - \square \\ \hline 2 \ 3 \end{array}$ |
| $\begin{array}{r} \square \ 6 \\ - \square \\ \hline 1 \ 1 \end{array}$ | $\begin{array}{r} \square \ 7 \\ - \square \\ \hline 1 \ 3 \end{array}$ | $\begin{array}{r} \square \ 9 \\ - \square \\ \hline 1 \ 6 \end{array}$ | $\begin{array}{r} \square \ 6 \\ - \square \\ \hline 1 \ 2 \end{array}$ | $\begin{array}{r} \square \ 8 \\ - \square \\ \hline 1 \ 5 \end{array}$ | $\begin{array}{r} \square \ 8 \\ - \square \\ \hline 1 \ 3 \end{array}$ |

Ens figurer med samme farve

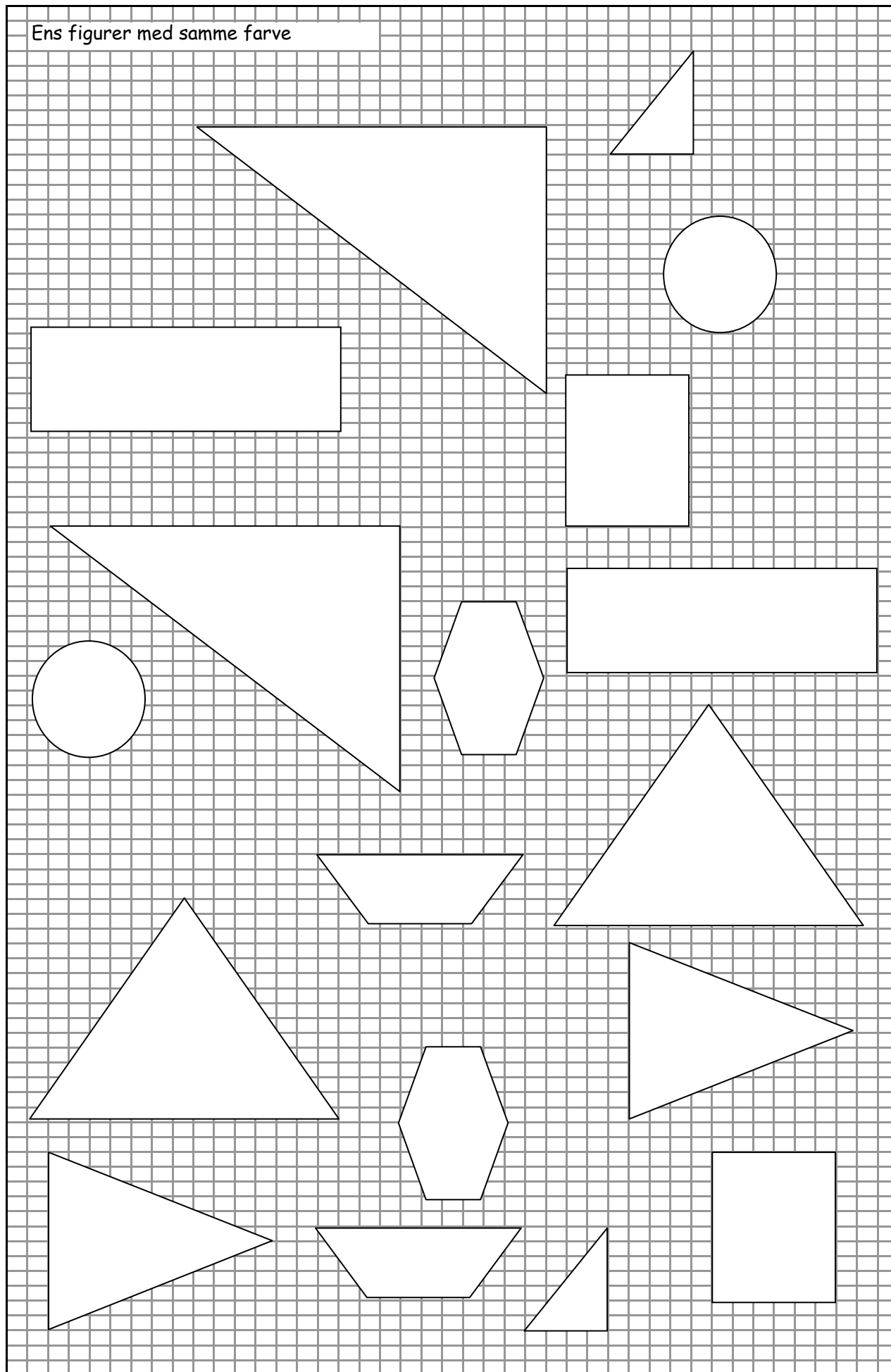

Indsæt >, < eller =

| | | |
|-------------------|-------------------|-------------------|
| $3 + 5 \square 7$ | $1 + 5 \square 4$ | $3 + 6 \square 8$ |
| $7 - 5 \square 2$ | $3 + 3 \square 6$ | $9 - 5 \square 2$ |
| $4 - 1 \square 5$ | $5 - 3 \square 8$ | $9 - 5 \square 5$ |
| $2 + 5 \square 6$ | $1 + 5 \square 4$ | $6 - 5 \square 1$ |

Træk streger til tallinjen

$5 - 3$
 $9 - 5$
 $11 - 2$
 $15 - 3$
 $19 - 3$
 $25 - 7$
 $17 + 4$
 $30 - 8$



$8 + 3$
 $9 - 7$
 $11 + 2$
 $15 + 3$
 $19 + 3$
 $15 + 7$
 $17 - 4$
 $26 + 3$

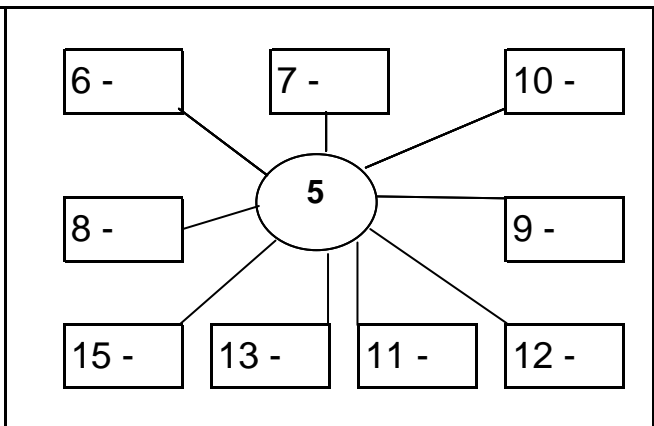
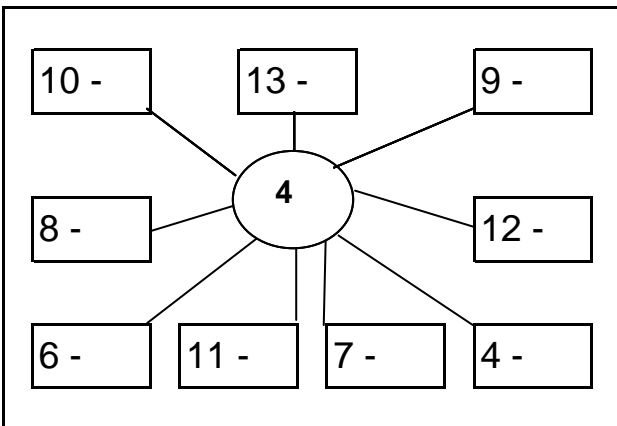
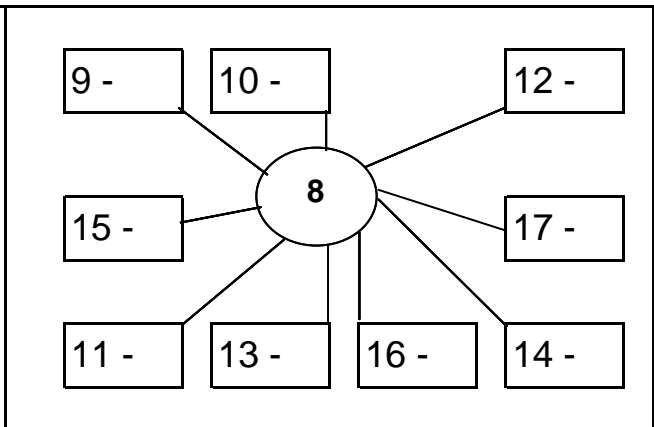
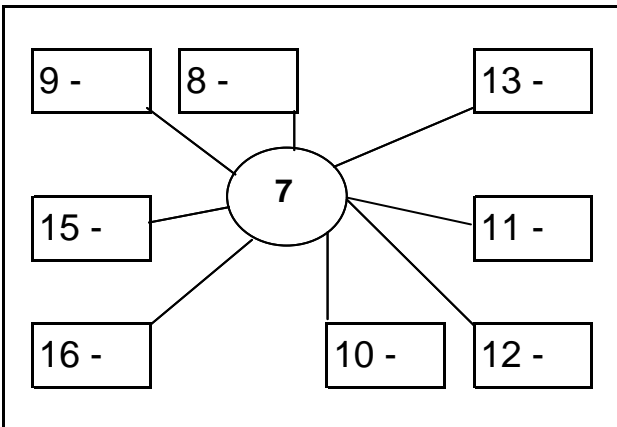

- 22 farves blåt
- 17 farves gult
- 14 farves orange
- 1 farves rødt
- 12 farves grønt
- 4 og 5 farves brunt
- 20 farves grønt

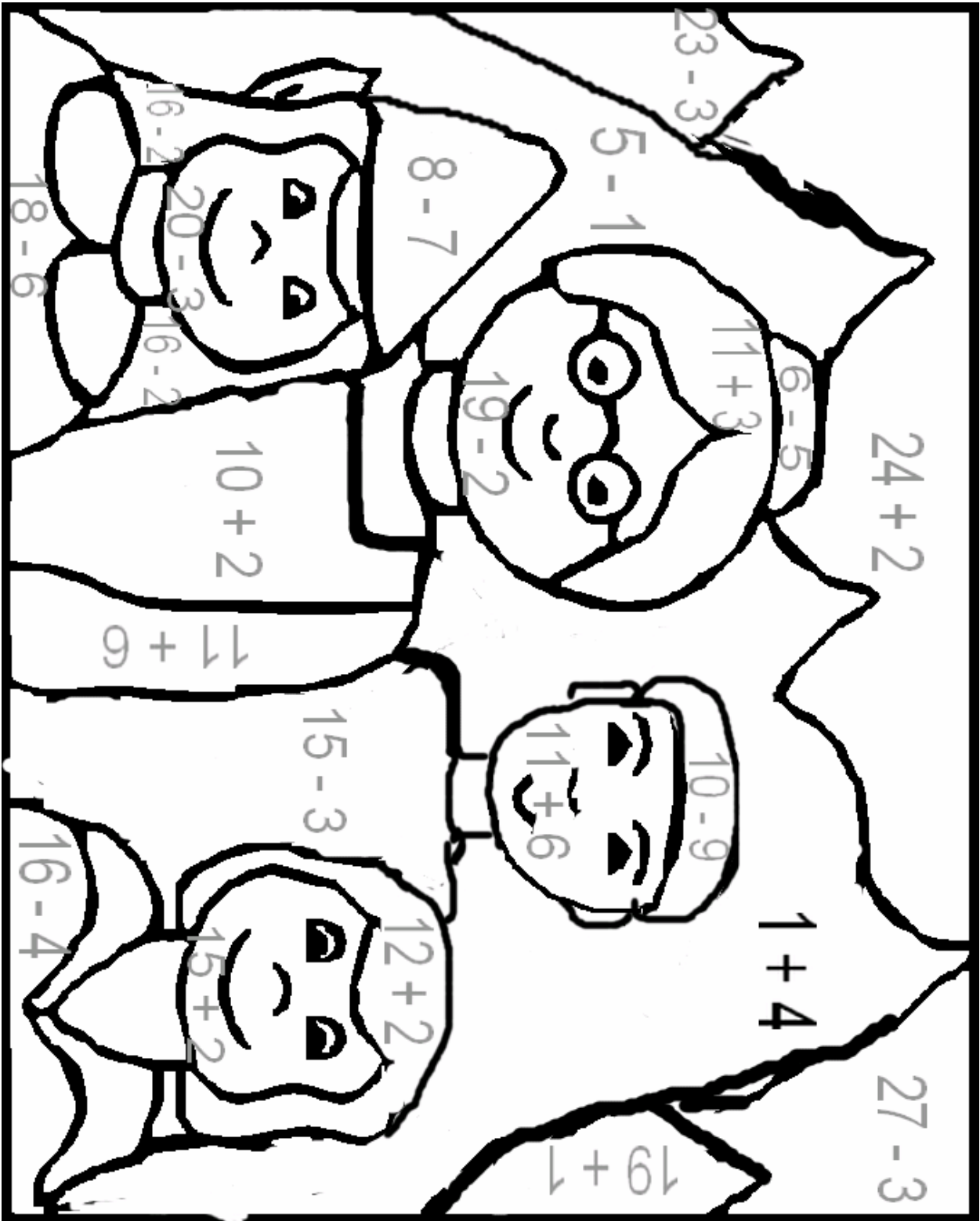

Træk streger til tallinjen



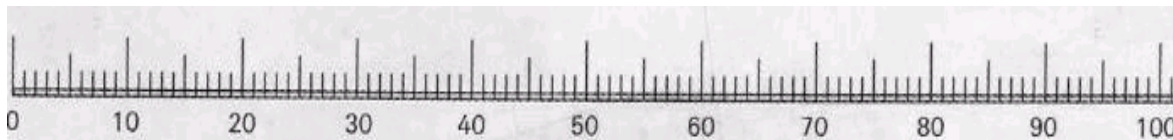

$10 + 20$ $30 + 10$ $10 + 30$ $20 + 20$ $20 + 10$ $10 + 50$ $50 + 20$ $80 + 10$

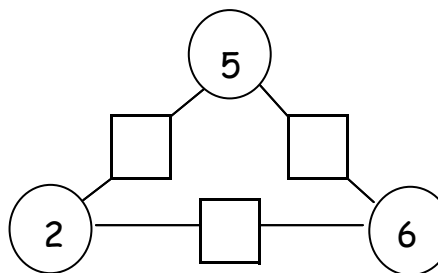
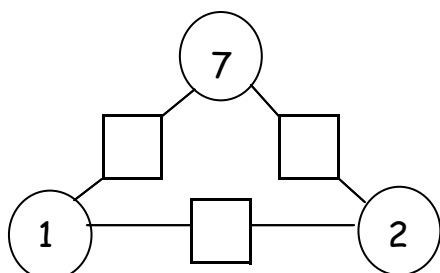
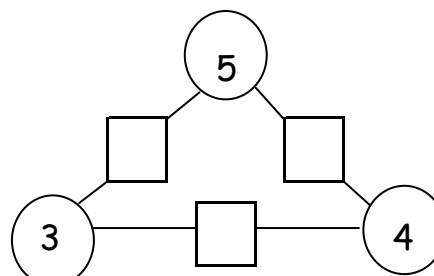
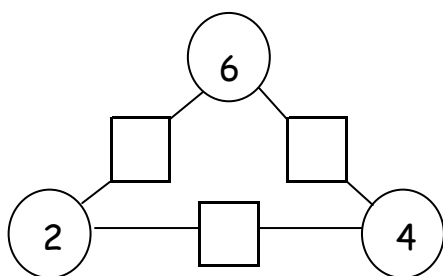
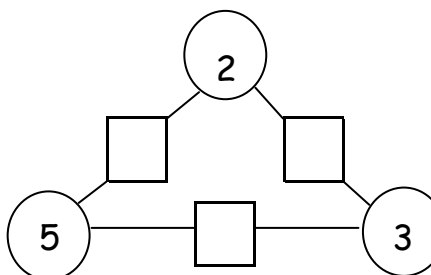
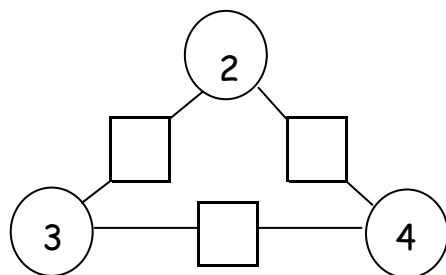
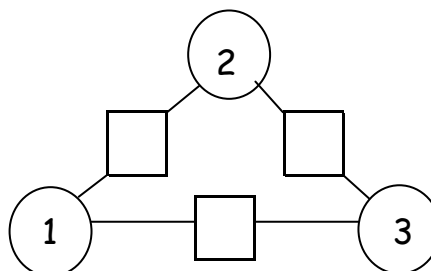
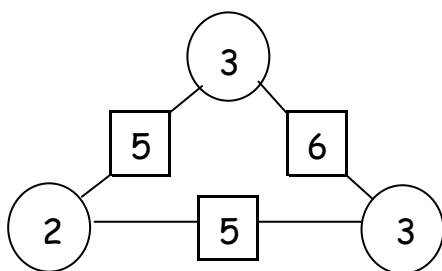







$0 + 10$ $20 + 10$ $30 + 20$ $40 + 10$ $50 + 10$ $10 + 40$ $40 + 40$ $70 + 10$









| | | | | | | | | | | | | | | | | | |
|---|---|---|---|---|---|---|---|---|----|----|----|----|----|----|----|----|----|
| 1 | 2 | 3 | 4 | 5 | 6 | 7 | 8 | 9 | 10 | 11 | 12 | 13 | 14 | 15 | 16 | 17 | 18 |
|---|---|---|---|---|---|---|---|---|----|----|----|----|----|----|----|----|----|



| | | | | | | |
|---|---|---|---|---|---|---|
|  | + |  | + |  | = |  |
| <input type="text" value="1"/> | + | <input type="text" value="2"/> | + | <input type="text" value="3"/> | = | <input type="text" value="6"/> |



| | | | | | | |
|---|---|--|---|---|---|----------------------|
|  | + |  | + |  | = | <input type="text"/> |
| <input type="text"/> | + | <input type="text"/> | + | <input type="text"/> | = | <input type="text"/> |



| | | | | | | |
|---|---|---|---|---|---|----------------------|
|  | + |  | + |  | = | <input type="text"/> |
| <input type="text"/> | + | <input type="text"/> | + | <input type="text"/> | = | <input type="text"/> |



| | | | | | | |
|---|---|--|---|---|---|----------------------|
|  | + |  | + |  | = | <input type="text"/> |
| <input type="text"/> | + | <input type="text"/> | + | <input type="text"/> | = | <input type="text"/> |



| | | | | | | |
|---|---|---|---|---|---|----------------------|
|  | + |  | + |  | = | <input type="text"/> |
| <input type="text"/> | + | <input type="text"/> | + | <input type="text"/> | = | <input type="text"/> |



| | | | | | | |
|---|---|--|---|---|---|----------------------|
|  | + |  | + |  | = | <input type="text"/> |
| <input type="text"/> | + | <input type="text"/> | + | <input type="text"/> | = | <input type="text"/> |



| | | | | | | |
|---|---|---|---|---|---|----------------------|
|  | + |  | + |  | = | <input type="text"/> |
| <input type="text"/> | + | <input type="text"/> | + | <input type="text"/> | = | <input type="text"/> |



| | | | | | | |
|---|---|--|---|---|---|----------------------|
|  | + |  | + |  | = | <input type="text"/> |
| <input type="text"/> | + | <input type="text"/> | + | <input type="text"/> | = | <input type="text"/> |

| | | | | | | |
|---|---|---|---|---|---|----------------------|
|  | + |  | + |  | = | <input type="text"/> |
| <input type="text"/> | + | <input type="text"/> | + | <input type="text"/> | = | <input type="text"/> |

| | | | | | | |
|---|---|--|---|---|---|----------------------|
|  | + |  | + |  | = | <input type="text"/> |
| <input type="text"/> | + | <input type="text"/> | + | <input type="text"/> | = | <input type="text"/> |

| | | | | | | |
|---|---|---|---|---|---|----------------------|
|  | + |  | + |  | = | <input type="text"/> |
| <input type="text"/> | + | <input type="text"/> | + | <input type="text"/> | = | <input type="text"/> |



| | | | | | | |
|---|---|--|---|---|---|----------------------|
|  | + |  | + |  | = | <input type="text"/> |
| <input type="text"/> | + | <input type="text"/> | + | <input type="text"/> | = | <input type="text"/> |



| | | | | | | |
|---|---|---|---|---|---|----------------------|
|  | + |  | + |  | = | <input type="text"/> |
| <input type="text"/> | + | <input type="text"/> | + | <input type="text"/> | = | <input type="text"/> |



| | | | | | | |
|----------------------|---|----------------------|---|----------------------|---|---------------------------------|
| <input type="text"/> | + | <input type="text"/> | + | <input type="text"/> | = | <input type="text" value="11"/> |
| <input type="text"/> | + | <input type="text"/> | + | <input type="text"/> | = | <input type="text" value="11"/> |



Reglerne er her: plusse to største tal minus det mindste tal



| | | | | | | | | | | | | | | | | | |
|---|---|---|---|---|---|---|---|---|----|----|----|----|----|----|----|----|----|
| 1 | 2 | 3 | 4 | 5 | 6 | 7 | 8 | 9 | 10 | 11 | 12 | 13 | 14 | 15 | 16 | 17 | 18 |
|---|---|---|---|---|---|---|---|---|----|----|----|----|----|----|----|----|----|



| | | | | | | |
|---|---|---|---|---|---|---|
|  |  |  | | | | |
| 5 | + | 3 | - | 1 | = | 7 |
| 8 | | - | 1 | = | 7 | |



| | | | | | | |
|---|---|---|---|---|---|--|
|  |  |  | | | | |
| | + | | - | | = | |
| | | - | | = | | |



| | | | | | | |
|---|---|---|---|---|---|--|
|  |  |  | | | | |
| | + | | - | | = | |
| | | - | | = | | |



| | | | | | | |
|---|---|---|---|---|---|--|
|  |  |  | | | | |
| | + | | - | | = | |
| | | - | | = | | |



| | | | | | | |
|---|---|---|---|---|---|--|
|  |  |  | | | | |
| | + | | - | | = | |
| | | - | | = | | |



| | | | | | | |
|---|---|---|---|---|---|--|
|  |  |  | | | | |
| | + | | - | | = | |
| | | - | | = | | |



| | | | | | | |
|---|---|---|---|---|---|--|
|  |  |  | | | | |
| | + | | - | | = | |
| | | - | | = | | |

| | | | | | | |
|---|---|---|---|---|---|--|
|  |  |  | | | | |
| | + | | - | | = | |
| | | - | | = | | |

| | | | | | | |
|---|---|---|---|---|---|--|
|  |  |  | | | | |
| | + | | - | | = | |
| | | - | | = | | |

| | | | | | | |
|---|---|---|---|---|---|--|
|  |  |  | | | | |
| | + | | - | | = | |
| | | - | | = | | |

| | | | | | | |
|---|---|---|---|---|---|--|
|  |  |  | | | | |
| | + | | - | | = | |
| | | - | | = | | |

| | | | | | | |
|---|---|---|---|---|---|--|
|  |  |  | | | | |
| | + | | - | | = | |
| | | - | | = | | |

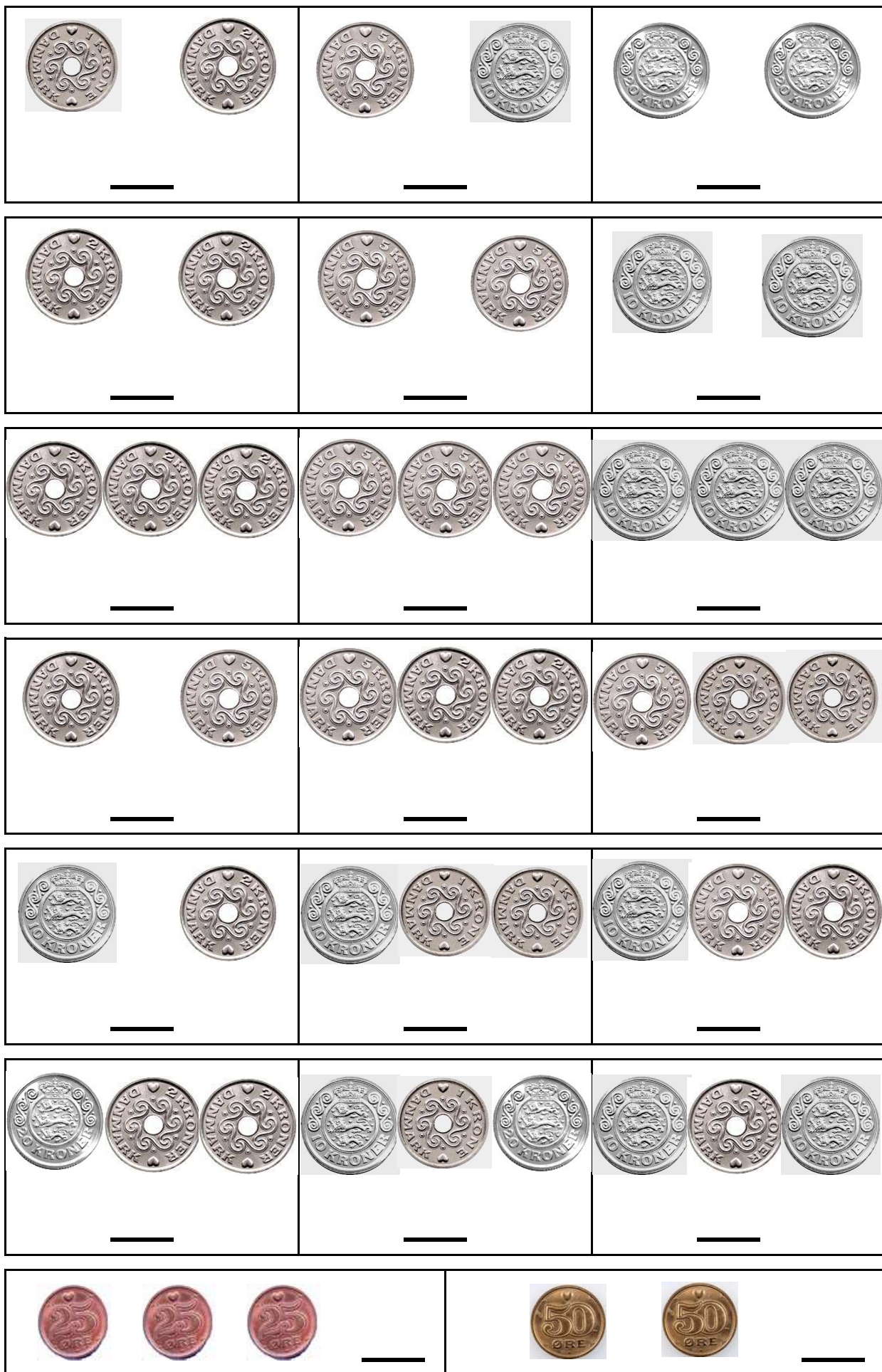

| | | | | | | | | | | | | | | | | | | | |
|---|--|---|---|---|---|---|--|---|--|--|--|--|--|--|--|--|--|--|--|
| 1 | | 3 | | 5 | | | | | | | | | | | | | | | |
| | | 3 | | | 6 | | | 9 | | | | | | | | | | | |
| 1 | | | 4 | | | 7 | | | | | | | | | | | | | |

| | | | | | | | | | | | | | | | | | | | |
|---|----|---|----|----|----|---|----|---|--|----|--|----|--|----|--|----|--|----|--|
| 0 | | 2 | | 4 | | 6 | | 8 | | 10 | | 12 | | 14 | | 16 | | 18 | |
| | 17 | | 19 | | 21 | | | | | | | | | | | | | | |
| | 22 | | | 25 | | | 28 | | | | | | | | | | | | |

| | | | | | | | | | | | | | | | | | | | |
|----|----|--|----|----|----|--|--|--|--|--|--|--|--|--|--|--|--|--|--|
| 10 | | | | | 15 | | | | | | | | | | | | | | |
| | 24 | | 26 | | | | | | | | | | | | | | | | |
| | 33 | | | 36 | | | | | | | | | | | | | | | |

| | | | | | | | | | | | | | | | | | | | |
|----|----|--|----|--|----|--|--|--|--|--|--|--|--|--|--|--|--|--|--|
| 33 | | | | | 38 | | | | | | | | | | | | | | |
| | 42 | | 44 | | | | | | | | | | | | | | | | |
| | 56 | | | | 60 | | | | | | | | | | | | | | |

| | | | | | | | | | | | | | | | | | | | |
|----|----|----|--|----|--|--|--|--|--|--|--|--|--|--|--|--|--|--|--|
| 61 | | 63 | | | | | | | | | | | | | | | | | |
| 47 | | 49 | | | | | | | | | | | | | | | | | |
| | 77 | | | 80 | | | | | | | | | | | | | | | |

| | | | | | | | | | | | | | | | | | | | |
|----|----|--|----|--|----|--|--|--|----|--|--|--|--|--|--|--|--|--|--|
| 10 | | | | | | | | | 20 | | | | | | | | | | |
| 15 | | | | | 20 | | | | | | | | | | | | | | |
| | 29 | | 31 | | | | | | | | | | | | | | | | |

| | | | | | | | | | | | | | | | | | | | |
|----|--|--|--|--|--|--|--|--|----|--|--|--|--|--|--|--|--|--|--|
| 50 | | | | | | | | | 60 | | | | | | | | | | |
|----|--|--|--|--|--|--|--|--|----|--|--|--|--|--|--|--|--|--|--|

Farv tal større end 0 og som er mindre end 30

| | | | | | | | | | | | | | | | | | | | |
|----|----|----|----|----|----|----|----|----|----|----|----|----|----|----|----|----|----|----|----|
| 33 | 55 | 66 | 66 | 49 | 72 | 61 | 55 | 66 | 66 | 49 | 72 | 61 | 55 | 66 | 66 | 49 | 72 | 61 | 64 |
| 46 | 3 | 56 | 77 | 2 | 46 | 99 | 19 | 26 | 11 | 9 | 44 | 46 | 55 | 88 | 89 | 24 | 61 | 49 | 99 |
| 67 | 5 | 38 | 79 | 6 | 67 | 96 | 4 | 55 | 78 | 37 | 59 | 67 | 55 | 78 | 90 | 17 | 37 | 59 | 96 |
| 77 | 11 | 39 | 66 | 9 | 77 | 94 | 23 | 55 | 59 | 77 | 72 | 77 | 55 | 59 | 91 | 18 | 77 | 72 | 94 |
| 45 | 26 | 69 | 58 | 18 | 45 | 89 | 27 | 55 | 66 | 55 | 52 | 45 | 55 | 66 | 34 | 23 | 55 | 52 | 89 |
| 54 | 16 | 44 | 34 | 25 | 54 | 84 | 13 | 55 | 33 | 88 | 44 | 54 | 55 | 33 | 40 | 28 | 88 | 44 | 84 |
| 99 | 18 | 15 | 29 | 19 | 99 | 81 | 17 | 6 | 22 | 5 | 67 | 99 | 66 | 33 | 56 | 12 | 64 | 56 | 81 |
| 67 | 9 | 56 | 77 | 25 | 67 | 76 | 7 | 45 | 70 | 90 | 88 | 67 | 55 | 43 | 31 | 25 | 72 | 62 | 76 |
| 55 | 13 | 38 | 79 | 17 | 55 | 71 | 11 | 44 | 44 | 55 | 46 | 55 | 34 | 66 | 77 | 13 | 42 | 88 | 71 |
| 44 | 14 | 39 | 66 | 27 | 44 | 69 | 22 | 82 | 66 | 50 | 34 | 44 | 55 | 46 | 66 | 25 | 46 | 47 | 69 |
| 33 | 27 | 69 | 58 | 18 | 33 | 64 | 15 | 33 | 77 | 89 | 55 | 33 | 6 | 59 | 73 | 13 | 54 | 90 | 64 |
| 78 | 15 | 44 | 34 | 11 | 78 | 59 | 23 | 16 | 29 | 7 | 55 | 78 | 2 | 14 | 12 | 15 | 63 | 77 | 59 |
| 59 | 56 | 96 | 65 | 81 | 90 | 56 | 36 | 66 | 99 | 34 | 99 | 78 | 57 | 36 | 15 | 66 | 59 | 36 | 45 |
| 48 | 83 | 56 | 96 | 65 | 45 | 50 | 54 | 57 | 61 | 66 | 56 | 96 | 65 | 81 | 97 | 58 | 92 | 58 | 73 |
| 79 | 77 | 66 | 96 | 96 | 38 | 47 | 33 | 44 | 66 | 88 | 33 | 49 | 65 | 81 | 97 | 66 | 76 | 89 | 35 |
| 12 | 19 | 59 | 66 | 94 | 11 | 37 | 59 | 14 | 37 | 59 | 60 | 14 | 16 | 20 | 66 | 25 | 12 | 19 | 12 |
| 18 | 44 | 17 | 89 | 89 | 24 | 77 | 72 | 15 | 77 | 72 | 49 | 15 | 68 | 42 | 88 | 8 | 66 | 98 | 18 |
| 17 | 56 | 89 | 26 | 84 | 22 | 55 | 52 | 16 | 55 | 52 | 59 | 16 | 51 | 46 | 47 | 19 | 56 | 56 | 17 |
| 22 | 91 | 90 | 17 | 81 | 16 | 88 | 44 | 17 | 88 | 44 | 72 | 17 | 34 | 54 | 90 | 4 | 77 | 45 | 22 |
| 14 | 77 | 35 | 22 | 76 | 18 | 79 | 35 | 18 | 66 | 88 | 89 | 18 | 33 | 63 | 77 | 9 | 12 | 19 | 14 |
| 12 | 91 | 69 | 25 | 71 | 13 | 66 | 77 | 19 | 37 | 59 | 59 | 19 | 16 | 20 | 45 | 23 | 49 | 33 | 12 |
| 19 | 91 | 90 | 29 | 69 | 17 | 99 | 65 | 20 | 77 | 72 | 72 | 16 | 44 | 42 | 88 | 29 | 59 | 87 | 16 |
| 25 | 91 | 95 | 27 | 64 | 29 | 43 | 77 | 21 | 55 | 52 | 52 | 17 | 58 | 46 | 47 | 4 | 88 | 45 | 17 |
| 14 | 91 | 69 | 25 | 59 | 18 | 82 | 86 | 22 | 88 | 44 | 88 | 18 | 59 | 54 | 90 | 15 | 64 | 66 | 18 |
| 13 | 92 | 17 | 45 | 45 | 15 | 49 | 94 | 23 | 88 | 73 | 47 | 19 | 35 | 63 | 77 | 27 | 72 | 88 | 19 |
| 11 | 10 | 55 | 73 | 73 | 12 | 16 | 20 | 24 | 88 | 56 | 90 | 20 | 12 | 19 | 78 | 15 | 42 | 96 | 16 |
| 64 | 64 | 56 | 96 | 65 | 81 | 97 | 58 | 92 | 58 | 73 | 77 | 72 | 64 | 64 | 79 | 80 | 46 | 54 | 54 |
| 99 | 99 | 56 | 96 | 65 | 66 | 88 | 90 | 92 | 67 | 73 | 77 | 61 | 59 | 59 | 64 | 64 | 54 | 33 | 33 |
| 96 | 96 | 56 | 96 | 65 | 37 | 59 | 65 | 81 | 97 | 58 | 92 | 58 | 73 | 73 | 74 | 75 | 76 | 77 | 78 |
| 94 | 11 | 23 | 5 | 17 | 77 | 72 | 11 | 18 | 19 | 15 | 61 | 77 | 25 | 29 | 94 | 64 | 72 | 61 | 64 |
| 89 | 14 | 49 | 78 | 19 | 55 | 52 | 14 | 72 | 77 | 15 | 49 | 55 | 8 | 72 | 28 | 60 | 61 | 49 | 99 |
| 84 | 6 | 55 | 52 | 89 | 88 | 44 | 6 | 52 | 55 | 17 | 59 | 88 | 19 | 52 | 52 | 25 | 37 | 59 | 96 |
| 81 | 23 | 69 | 59 | 59 | 84 | 81 | 23 | 44 | 88 | 26 | 72 | 64 | 4 | 44 | 44 | 8 | 77 | 88 | 94 |
| 76 | 29 | 79 | 73 | 54 | 69 | 76 | 29 | 56 | 64 | 25 | 52 | 72 | 9 | 56 | 56 | 19 | 55 | 64 | 89 |
| 71 | 4 | 78 | 55 | 52 | 89 | 71 | 4 | 62 | 72 | 8 | 44 | 42 | 23 | 62 | 62 | 4 | 88 | 72 | 84 |
| 69 | 25 | 97 | 55 | 76 | 56 | 69 | 15 | 88 | 42 | 19 | 56 | 46 | 29 | 88 | 88 | 9 | 64 | 42 | 81 |
| 64 | 8 | 56 | 12 | 15 | 34 | 64 | 15 | 47 | 46 | 4 | 62 | 54 | 4 | 47 | 47 | 17 | 72 | 46 | 76 |
| 59 | 19 | 47 | 47 | 15 | 94 | 59 | 17 | 54 | 54 | 9 | 88 | 63 | 15 | 55 | 45 | 15 | 42 | 54 | 71 |
| 45 | 4 | 72 | 84 | 17 | 67 | 45 | 26 | 62 | 63 | 17 | 47 | 59 | 27 | 78 | 18 | 66 | 46 | 63 | 69 |
| 73 | 9 | 22 | 18 | 26 | 78 | 73 | 22 | 25 | 27 | 26 | 90 | 92 | 29 | 28 | 67 | 55 | 54 | 90 | 64 |
| 35 | 55 | 52 | 89 | 47 | 78 | 35 | 55 | 52 | 89 | 45 | 77 | 76 | 55 | 52 | 89 | 49 | 63 | 77 | 59 |
| 45 | 78 | 98 | 99 | 55 | 52 | 89 | 45 | 33 | 78 | 96 | 34 | 56 | 67 | 59 | 76 | 82 | 59 | 36 | 45 |

Find vej med resultat mellem 0 og 20

| | | | | | | | | | | | | |
|----------|----------|----------|----------|----------|----------|----------|----------|----------|----------|----------|----------|----------|
| $44 + 4$ | $7 + 5$ | $12 + 4$ | $41 + 3$ | $44 + 8$ | $77 + 2$ | $55 + 2$ | $50 + 2$ | $88 + 4$ | $76 + 5$ | $82 + 4$ | $33 + 5$ | $38 + 4$ |
| $42 + 4$ | $23 + 5$ | $92 + 4$ | $1 + 3$ | $11 + 3$ | $61 + 3$ | $73 + 5$ | $66 + 3$ | $53 + 2$ | $91 + 3$ | $61 + 1$ | $83 + 3$ | $76 + 4$ |
| $52 + 8$ | $72 + 2$ | $53 + 1$ | $33 + 7$ | $49 + 7$ | $3 + 3$ | $4 + 4$ | $64 + 8$ | $61 + 5$ | $68 + 3$ | $77 + 8$ | $82 + 7$ | $64 + 1$ |
| $88 + 1$ | $77 + 5$ | $98 + 1$ | $37 + 3$ | $65 + 3$ | $76 + 3$ | $66 + 2$ | $6 + 3$ | $17 + 2$ | $66 + 8$ | $66 + 1$ | $99 + 3$ | $55 + 2$ |
| $34 + 6$ | $93 + 6$ | $67 + 2$ | $29 + 6$ | $15 + 4$ | $75 + 6$ | $75 + 6$ | $75 + 6$ | $75 + 6$ | $75 + 6$ | $75 + 6$ | $75 + 6$ | $75 + 6$ |



| | | | | | | | | | | | | | | | | | | | |
|--|---|---|--|--|--|---|---|---|---|---|--|--|--|--|--|--|---|---|---|
| <table border="1"> <tr><td></td><td></td><td></td></tr> <tr><td></td><td></td><td>8</td></tr> <tr><td>6</td><td>6</td><td>2</td></tr> </table> | | | | | | 8 | 6 | 6 | 2 | <table border="1"> <tr><td></td><td></td><td></td></tr> <tr><td></td><td></td><td></td></tr> <tr><td>5</td><td>2</td><td>5</td></tr> </table> | | | | | | | 5 | 2 | 5 |
| | | | | | | | | | | | | | | | | | | | |
| | | 8 | | | | | | | | | | | | | | | | | |
| 6 | 6 | 2 | | | | | | | | | | | | | | | | | |
| | | | | | | | | | | | | | | | | | | | |
| | | | | | | | | | | | | | | | | | | | |
| 5 | 2 | 5 | | | | | | | | | | | | | | | | | |

| | | | | | | | | | | | | | | | | | | | |
|---|---|---|--|--|--|--|---|---|---|---|--|--|--|--|--|--|---|---|---|
| <table border="1"> <tr><td></td><td></td><td></td></tr> <tr><td></td><td></td><td></td></tr> <tr><td>4</td><td>2</td><td>5</td></tr> </table> | | | | | | | 4 | 2 | 5 | <table border="1"> <tr><td></td><td></td><td></td></tr> <tr><td></td><td></td><td></td></tr> <tr><td>6</td><td>2</td><td>4</td></tr> </table> | | | | | | | 6 | 2 | 4 |
| | | | | | | | | | | | | | | | | | | | |
| | | | | | | | | | | | | | | | | | | | |
| 4 | 2 | 5 | | | | | | | | | | | | | | | | | |
| | | | | | | | | | | | | | | | | | | | |
| | | | | | | | | | | | | | | | | | | | |
| 6 | 2 | 4 | | | | | | | | | | | | | | | | | |